



CATÁLOGO DE PRODUCTOS
OJARA 2025

A row of shirts hanging on a rack in a store. The shirts are in various colors including white, green, yellow, and blue. The rack is made of metal hangers. The text 'NOS ENGANCHAMOS A LA CALIDAD' is overlaid in white, bold, sans-serif font. A red horizontal line is positioned under the word 'ENGANCHAMOS'.

NOS ENGANCHAMOS
A LA CALIDAD

En Ojara, reconocemos la importancia de la economía circular como un enfoque fundamental en nuestra operación. Nos comprometemos a cerrar el ciclo de vida de nuestros productos, desde su diseño hasta su disposición final, minimizando el desperdicio y maximizando el valor de los recursos. Adoptamos prácticas que fomentan la reutilización, el reciclaje y la remanufactura, asegurando que nuestros productos y materiales mantengan su utilidad y valor a lo largo del tiempo. Al priorizar la economía circular, no solo reducimos nuestro impacto ambiental, sino que también impulsamos la innovación, la eficiencia y la resiliencia en nuestra cadena de suministro y más allá.

EMPACAMOS



RECICLAMOS



DISTRIBUIMOS



RECOGEMOS



ECONOMÍA CÍRCULAR

SELECCIONAMOS



RECUPERAMOS



REFABRICAMOS



Contamos con una gama de más de 200 referencias de ganchos especializados, diseñados para adaptarse a todo tipo de prendas. Entendemos que cada artículo requiere un gancho específico para una presentación óptima, por eso ofrecemos una variedad de estilos, colores y opciones personalizadas para satisfacer tus necesidades. Nuestros ganchos están diseñados para seguir las tendencias de la industria de la moda, garantizando calidad y estilo en cada presentación.

Si no encuentras el gancho que estás buscando en nuestro catálogo, ¡no te preocupes! En Ojara, estamos listos para diseñar y fabricar el gancho perfecto para ti. Confía en nosotros para brindarte soluciones a medida que se adapten a tus necesidades específicas.

ELIGE



LÍNEA BÁSICA

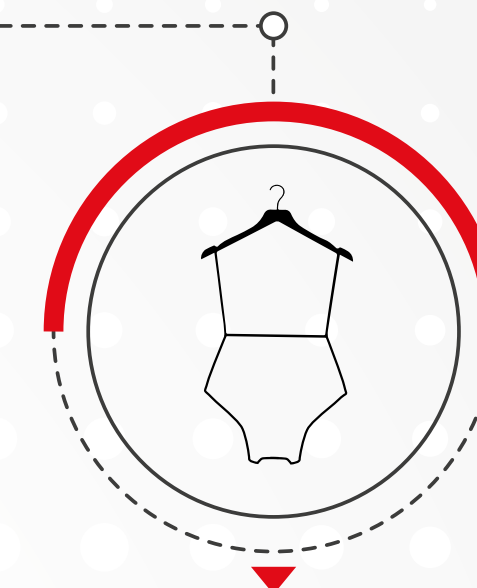

LÍNEA PREMIUM

PERSONALIZA EL COLOR

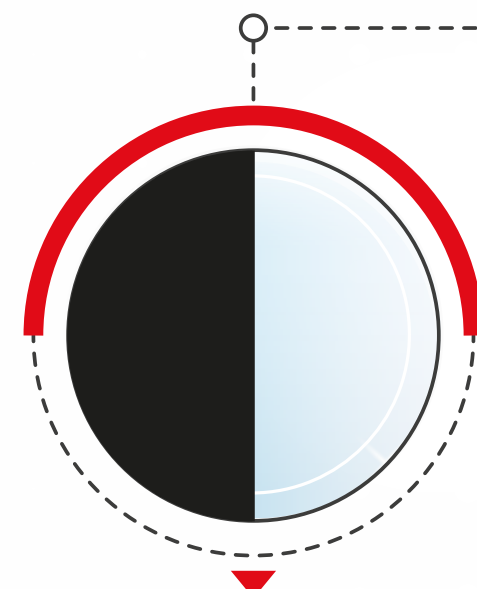

COLORES DE LÍNEA

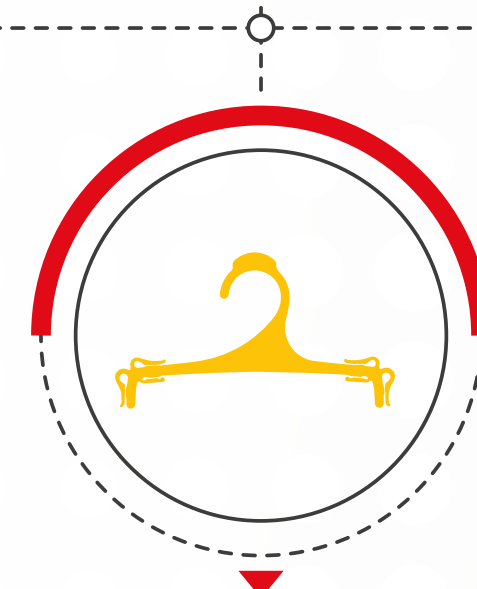

PERSONALIZADOS



OTROS

PERSONALIZA EL ESTAMPADO



1 TINTA



2 TINTAS



SUPERIOR

Ganchos ideales para colgar prendas superiores como: camisetas, camisas, blusas, busos, chalecos y tops.



41,5cm
21,5cm
4mm

8, 10, 12, 14, 16, 18, 20,
S, M, L

REF: 370



40,6cm
19cm
7,2mm

8, 10, 12, 14, 16, 18, 20,
S, M, L

REF: 386



43,6cm
22,5cm
9,7mm

8, 10, 12, 14, 16, 18, 20,
S, M, L

REF: 390



42cm
21cm
6,7mm

8, 10, 12, 14, 16, 18, 20,
S, M, L

REF: 480



43,2cm
23cm
9mm

S, M, L, XL, XXL,
34, 36, 38, 40

REF: 484



39,5cm
23cm
9,2mm

8, 10, 12, 14, 16, 18, 20,
S, M, L

REF: 490



42,5cm
24,1cm
10,9mm

8, 10, 12, 14, 16, 18, 20,
S, M, L

REF: 490G



43,3cm
25,2cm
25,8mm

8, 10, 12, 14, 16, 18, 20,
S, M, L

REF: 492G



43,2cm
22,9cm
9mm

8, 10, 12, 14, 16, 18, 20,
S, M, L, 34, 36, 38, 40

REF: 484B



45,8cm
24cm
9mm

S, M, L, XL,
34, 36, 38, 40

REF: 491



40,1cm
22,8cm
9,2mm

8, 10, 12, 14, 16, 18, 20,
S, M, L

REF: 490B

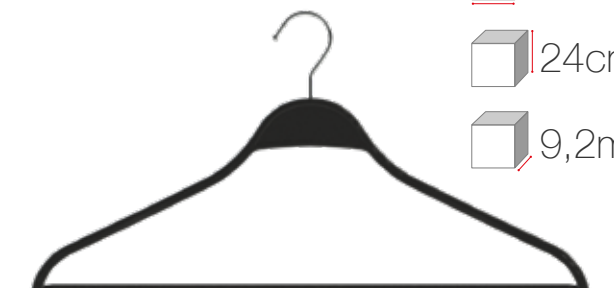

46,5cm
24cm
9,2mm

S, M, L, XL,
34, 36, 38, 40

REF: 491B



45,5cm
24,4cm
35,8mm

F: 12, 14, 16, 18, 20, 22
M: 32, 34, 36, 38

REF: 32



43,2cm
26,2cm
9,2mm

8, 10, 12, 14, 16, 18, 20,
S, M, L, 34, 36, 38, 40

REF: 484BP



40,7cm
21cm
10,7mm

S, M, L, XL, XXL,
34, 36, 38

REF: 38



43,6cm
26,3cm
28,4mm

8, 10, 12, 14, 16, 18, 20,
S, M, L

REF: 390A



43,6cm
41,4cm
28,4mm

8, 10, 12, 14, 16, 18, 20,
S, M, L

REF: 390B



43,6cm
41,4cm
28,4mm

8, 10, 12, 14, 16, 18, 20,
S, M, L

REF: 390BF



40,5cm
20,7cm
9,6mm

8, 10, 12, 14, 16, 18, 20,
S, M, L

REF: 484E



44,2cm
25cm
7,2mm

S, M, L, XL,
34, 36, 38, 40

REF: 500



43,6cm
22,5m
7,2mm

8, 10, 12, 14, 16, 18, 20,
S, M, L

REF: 391



43,6cm
22,5m
7,2mm

8, 10, 12, 14, 16, 18, 20,
S, M, L

REF: 392

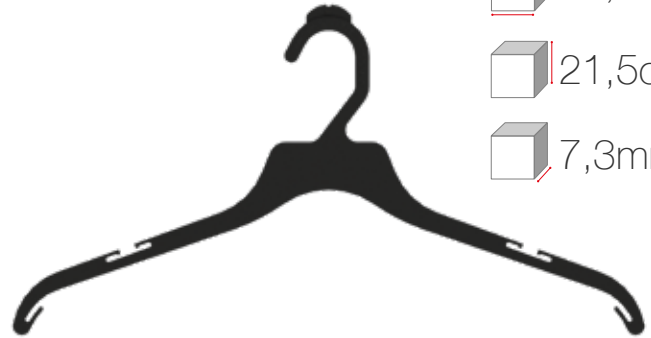

42,5cm
21,5cm
7,3mm

F: 12,14,16,18
M: 34, 36,38, 40, XS, S, M, L

REF: 17G



42,5cm
21,5cm
5,6mm

F: 12,14,16,18
M: 34, 36,38, 40, XS, S, M, L

REF: 17F



39,2cm
21cm
6,1mm

8, 10, 12, 14, 16, 18, 20,
S, M, L

REF: 18A



47cm
22,5cm
8,7mm

22, 24, 42, 44, 46,
S, M, L, XL, XXL

REF: 19A



46,8cm
22,5cm
8,4mm

22, 24, 42, 44, 46,
S, M, L, XL, XXL

REF: 19B

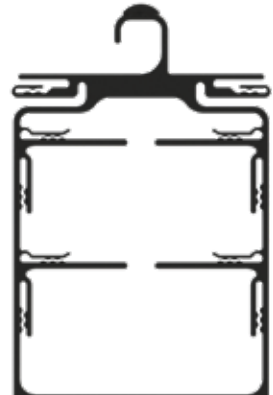

21,8cm
33,8cm
3mm

8, 10, 12, 14, 16, 18, 20,
S, M, L

REF: 23

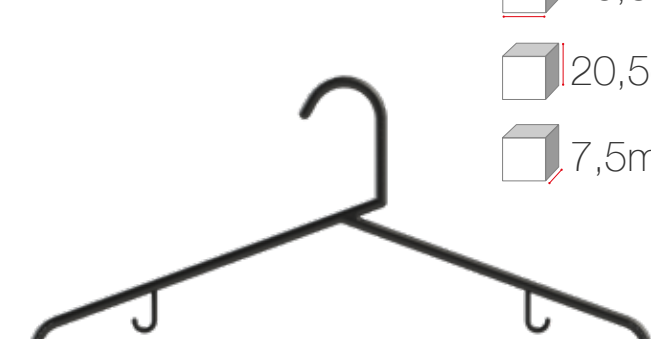

40,5cm
20,5cm
7,5mm

REF: 20C

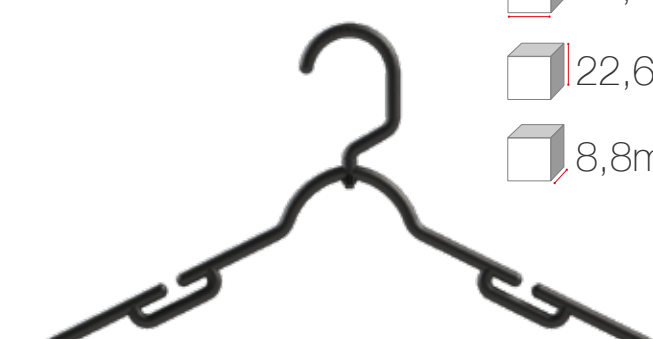

42,4cm
22,6cm
8,8mm

REF: 20



41,8cm
21,8cm
9mm

REF: 20A

Ganchos ideales para colgar prendas superiores como: camisetas, camisas, blusas, busos, chalecos y tops.

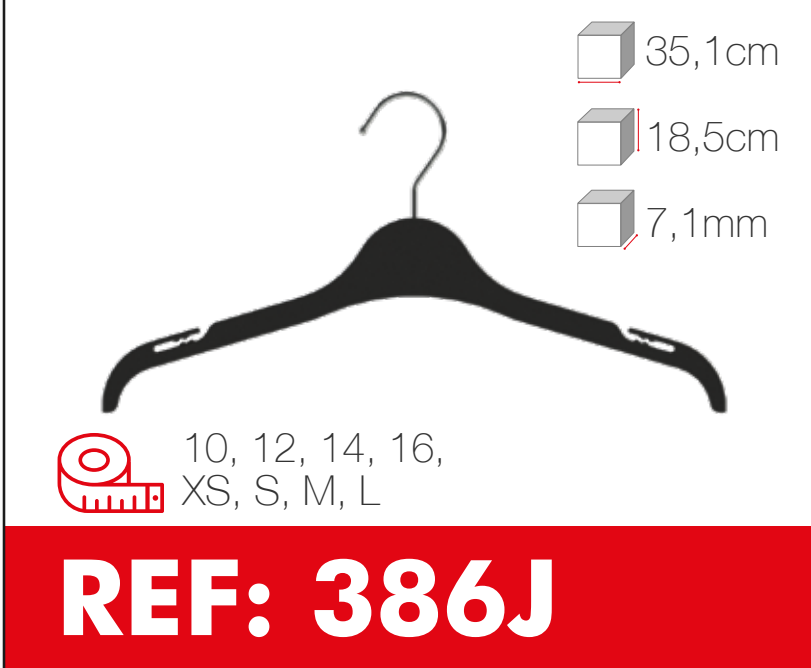

35,1cm
18,5cm
7,1mm

10, 12, 14, 16,
XS, S, M, L

REF: 386J



37,2cm
20cm
7mm

10, 12, 14, 16,
XS, S, M, L

REF: 485



37,2cm
20cm
7mm

10, 12, 14, 16,
XS, S, M, L

REF: 485B



37,2cm
24cm
25,7mm

10, 12, 14, 16,
XS, S, M, L

REF: 485BP



37cm
20cm
6,7mm

10, 12, 14, 16,
XS, S, M, L

REF: 480J



35,5cm
20cm
9,3mm

10, 12, 14, 16,
XS, S, M, L

REF: 485E



38,2cm
21,8cm
7,2mm

8, 10, 12, 14, 16, 18, 20,
S, M, L

REF: 385

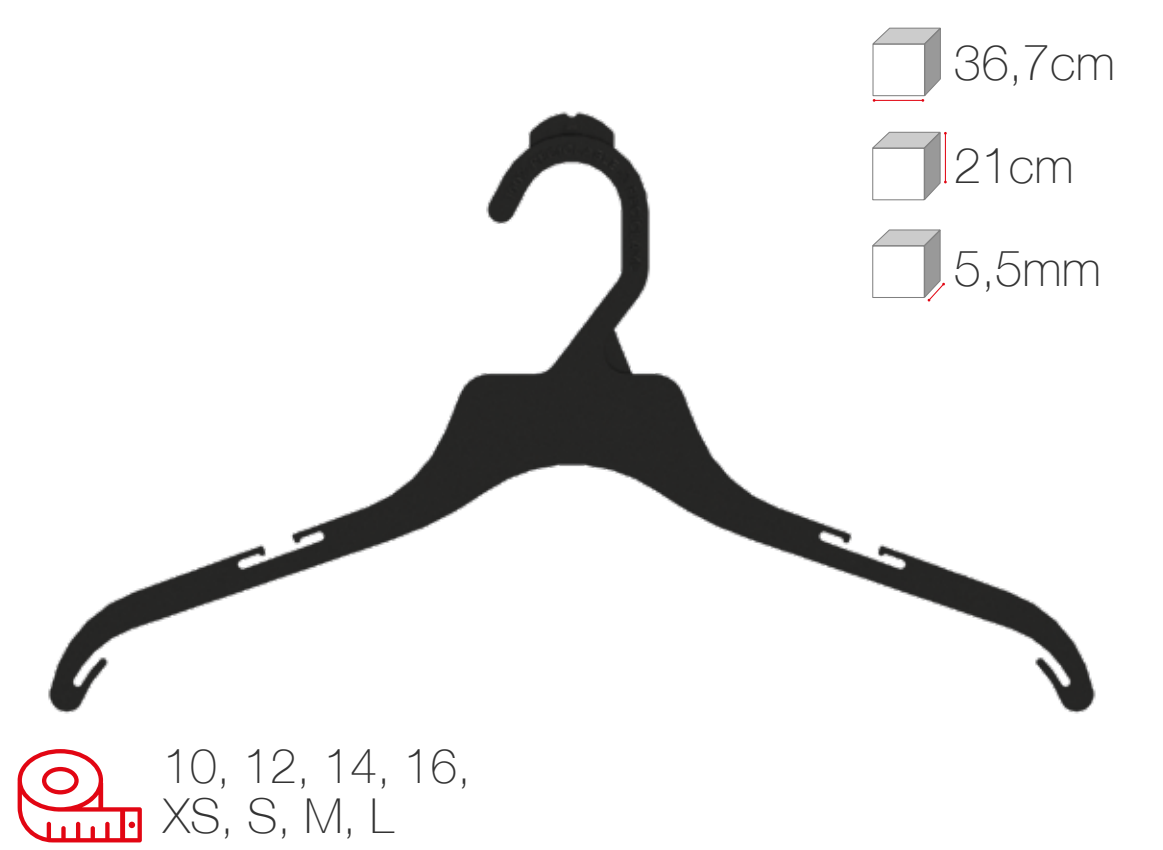

REF: 15F

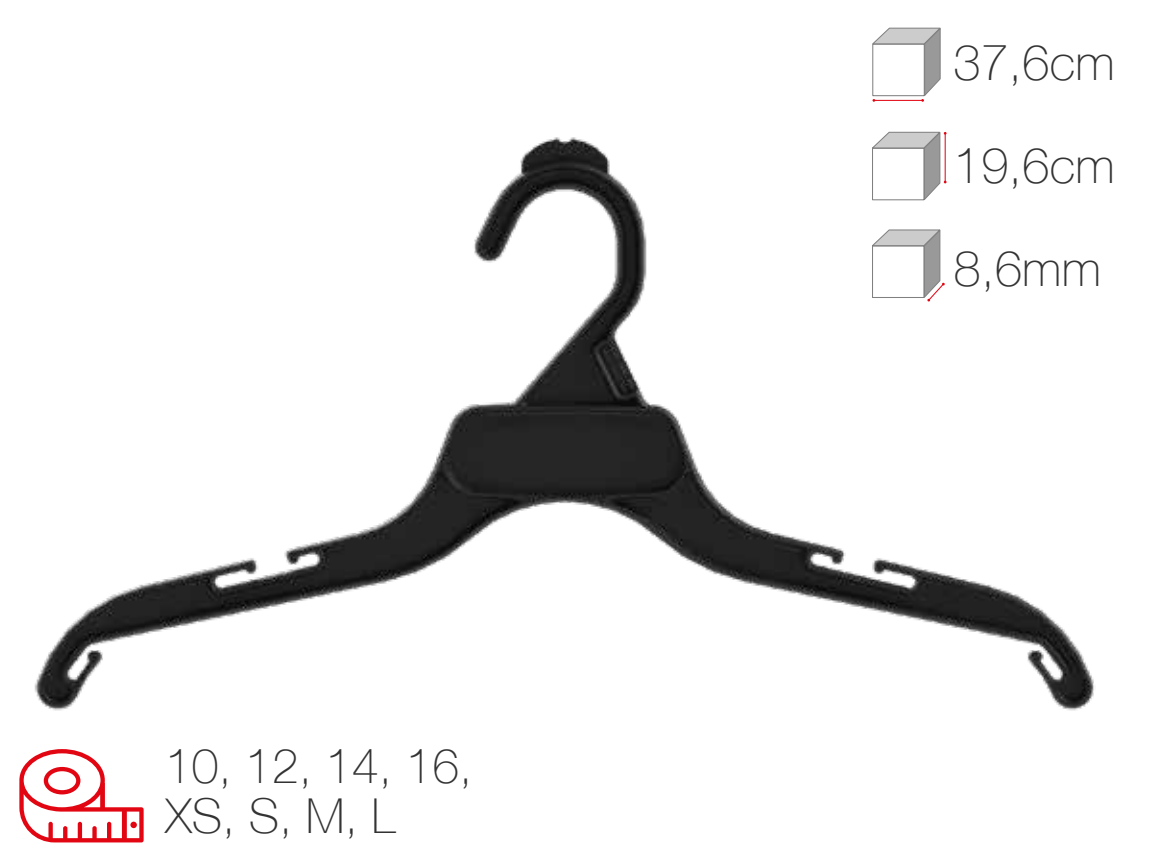

REF: 15G

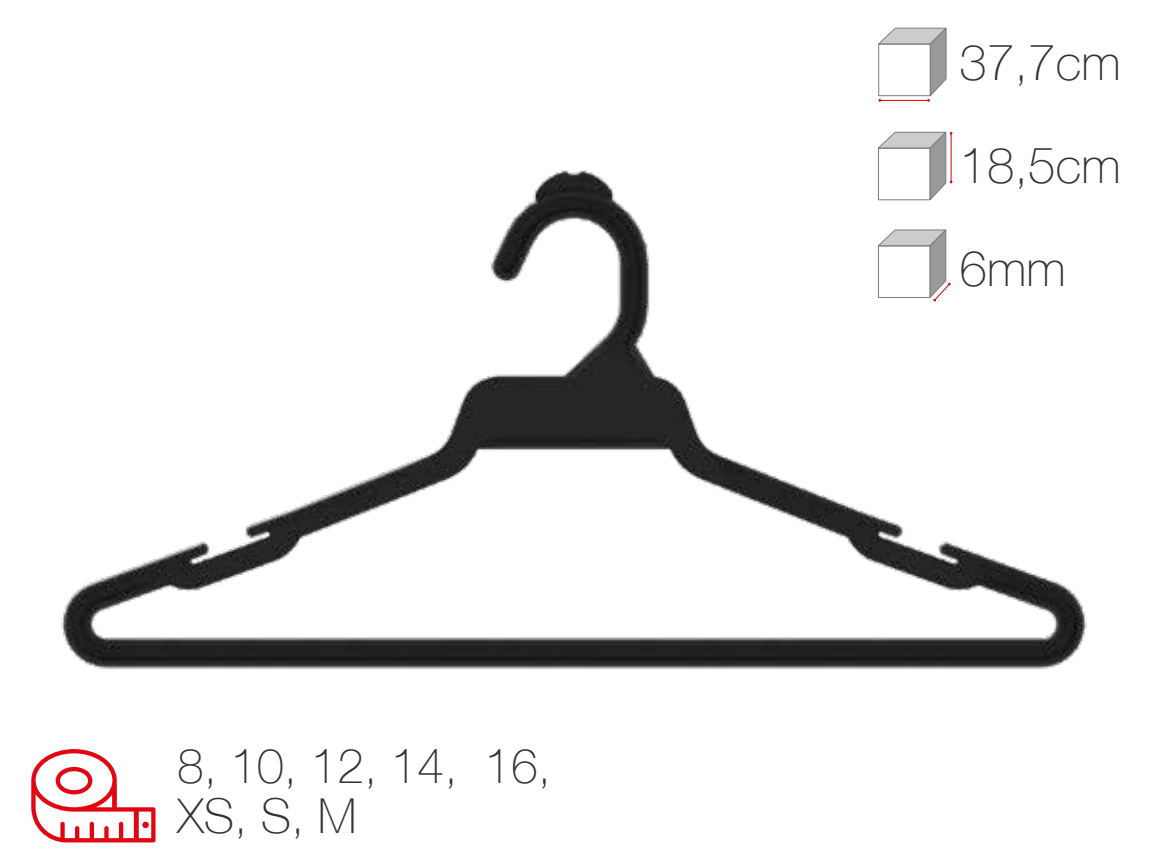

REF: 16

Ganchos ideales para colgar prendas superiores como: camisetas, camisas, blusas, busos, chalecos y tops.

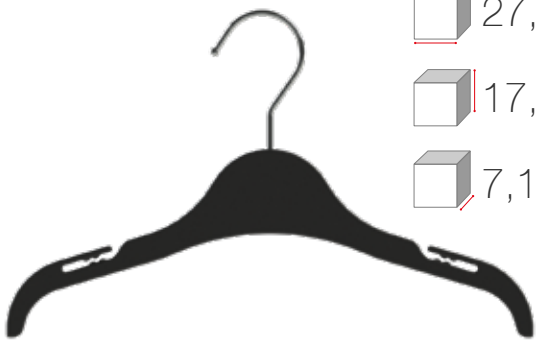

27,7cm
17,5cm
7,1mm

2, 4, 6, 8

REF: 386K



28,5cm
18cm
10mm

0, 0/3, 3/6, 6/12, 12/18, 18/24, 24/36, 38 bebe.

REF: 390K



30cm
17,3cm
9,5mm

2, 4, 6, 8

REF: 480K

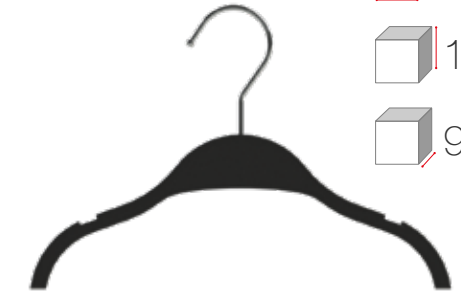

24cm
17,3cm
9,5mm

2, 4, 6, 8

REF: 481K



23,7cm
17,7cm
7mm

0/0, 3/3, 6/6, 9/9, 12/12, 18/18, 24

REF: 497



30,8cm
19cm
6,95mm

2, 4, 6, 8, 2T, 3T, 4T, 5T

REF: 498



30cm
19,3cm
7mm

2, 4, 6, 8, 2T, 3T, 4T, 5T

REF: 498B



30cm
23cm
27mm

2, 4, 6, 8, 2T, 3T, 4T, 5T

REF: 498BP



26cm
38,8cm
4,5mm

2, 4, 6, 8

REF: 13E



30cm
39,3cm
4,5mm

2, 4, 6, 8

REF: 13EA



29,6cm
18,5cm
7,8mm

2, 4, 6, 8, 2T, 3T, 4T, 5T

REF: 498E

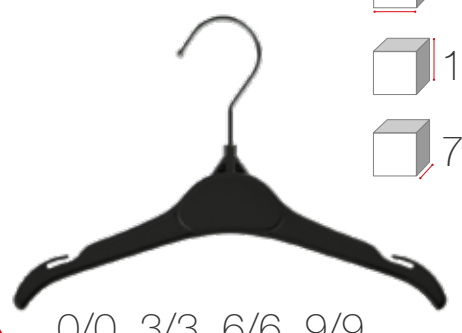

25,3cm
17,1cm
7,65mm

0/0, 3/3, 6/6, 9/9, 12/12, 18/18, 24

REF: 497E

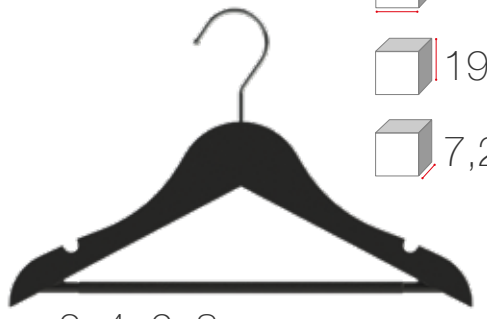

30,5cm
19,2cm
7,2mm

2, 4, 6, 8, 2T, 3T, 4T, 5T

REF: 502

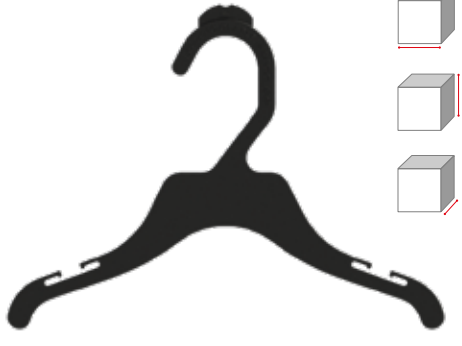

24cm
17,7cm
5mm

0, 0/3, 3/6, 6/12, 12/18, 18/24, 24/36, 38 bebe.

REF: 11F

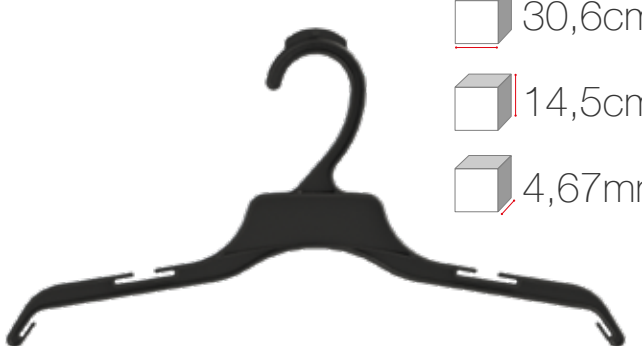

30,6cm
14,5cm
4,67mm

2, 4, 6, 8, 2T, 3T, 4T, 5T

REF: 12A



31,5cm
19,5cm
5mm

2, 4, 6, 8, 2T, 3T, 4T, 5T

REF: 12F



31,3cm
19cm
8,6mm

2, 4, 6, 8, 2T, 3T, 4T, 5T

REF: 12G



30cm
18,4cm
5,2mm

2, 4, 6, 8

REF: 14



22cm
14cm
6mm

0, 0/3, 3/6, 6/12, 12/18, 18/24, 24/36, 38 bebe.

REF: 11-2



22cm
16,3cm
6,1mm

0, 0/3, 3/6, 6/12, 12/18, 18/24, 24/36, 38 bebe.

REF: 11-3



22cm
21cm
6,2mm

0, 0/3, 3/6, 6/12, 12/18, 18/24, 24/36, 38 bebe.

REF: 11-5



20,5cm
29,6cm
4,7mm

2, 4, 6, 8

REF: 11-10A



20,4cm
29,6cm
4,7mm

2, 4, 6, 8

REF: 11-10A-2



30,2cm
29,5cm
4,7mm

2, 4, 6, 8

REF: 12-10A

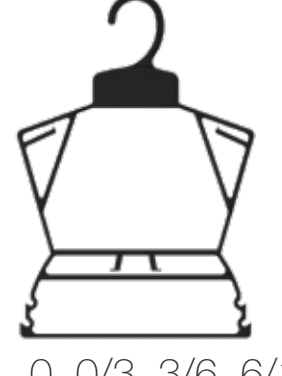

22,8cm
33,5cm
4,6mm

0, 0/3, 3/6, 6/12, 12/18, 18/24, 24/36, 38 bebe.

REF: 13

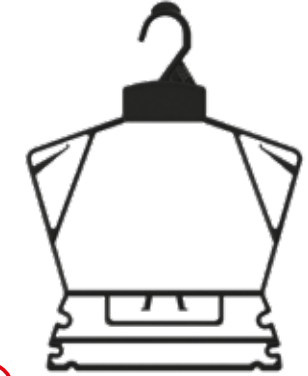

28,3cm
37,1cm
4,6mm

2, 4, 6, 8

REF: 13A



29,3cm
15,6cm
4,5mm

REF: 28A

A close-up, shallow depth-of-field photograph of a clothing store's denim section. A row of blue denim jeans is hanging on silver metal hangers. The focus is sharp on the jeans in the middle ground, while the foreground and background are blurred. The lighting is warm and slightly dim, creating a moody atmosphere. Overlaid in the center of the image is the word "INFERIOR" in a bold, white, sans-serif font. A thin red horizontal line underlines the text.

INFERIOR

Ganchos ideales para pantalones, faldas, short, bermudas y otras prendas inferiores.



29,4cm
15,7cm
20,3mm

16, 18, 20, 22, 24, 36, 38, 40

REF: 30ACM



35cm
15,9cm
20,3mm

42, 44, 46,
M, L, XL, XXL, XXXL

REF: 35ACM

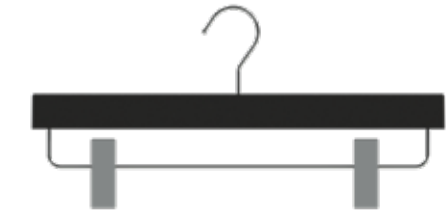

35,5cm
17,5cm
2,8mm

F: 8, 10, 12, 14, 16, 18, S, M, L
M: 32, 34, 36, 38, 40

REF: 373



36,5cm
16,2cm
9,5mm

8, 10, 12, 14, 16, 18, 20,
S, M, L

REF: 493A



36,5cm
19,3cm
9,5mm

8, 10, 12, 14, 16, 18, 20,
S, M, L

REF: 493A-H

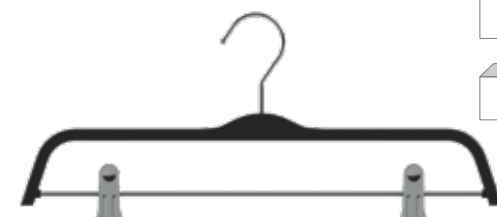

37,9cm
17cm
10mm

8, 10, 12, 14, 16, 18, 20,
S, M, L

REF: 493G



37,4cm
15,3cm
26mm

F: 8, 10, 12, 14, 16, 18, S, M, L
M: 32, 34, 36, 38, 40

REF: 487

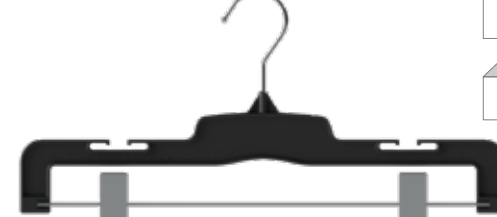

36,4cm
18,8cm
9,7mm

F: 8, 10, 12, 14, 16, 18, S, M, L
M: 32, 34, 36, 38, 40

REF: 488



43,2cm
22,9cm
9mm

8, 10, 12, 14, 16, 18, 20,
S, M, L, 34, 36, 38, 40

REF: 484B

Ganchos ideales para pantalones, faldas, short, bermudas y otras prendas inferiores.



40,1cm
22,8cm
9,2mm

8, 10, 12, 14, 16, 18, 20,
S, M, L

REF: 490B



46,5cm
24cm
9,2mm

S, M, L, XL,
34, 36, 38, 40

REF: 491B



45,5cm
24,4cm
35,8mm

F: 12, 14, 16, 18, 20, 22
M: 32, 34, 36, 38

REF: 32



43,2cm
26,2cm
9,2mm

8, 10, 12, 14, 16, 18, 20,
S, M, L, 34, 36, 38, 40

REF: 484BP



43,6cm
26,3cm
28,4mm

8, 10, 12, 14, 16, 18, 20,
S, M, L

REF: 390A



43,6cm
41,4cm
28,4mm

8, 10, 12, 14, 16, 18, 20,
S, M, L

REF: 390B



43,6cm
41,4cm
28,4mm

8, 10, 12, 14, 16, 18, 20,
S, M, L

REF: 390BF

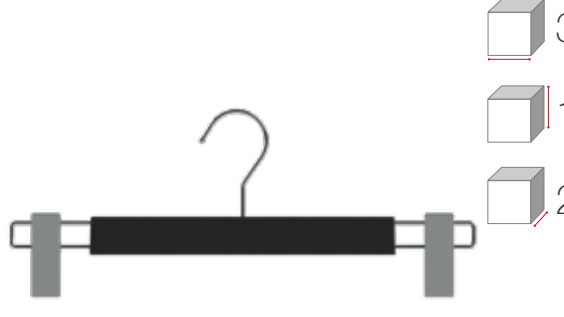

33,4cm
13,3cm
27,7mm

F: 8, 10, 12, 14, 16, 18, 20,
S, M, L
M: 32, 34, 36, 38, 40

REF: 393C

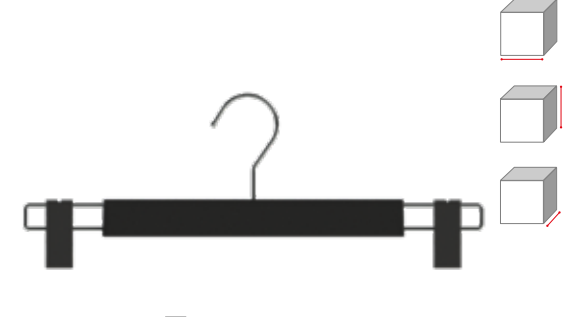

33,4cm
12,5cm
27,7mm

F: 8, 10, 12, 14, 16, 18,
S, M, L
M: 32, 34, 36, 38, 40

REF: 393CH

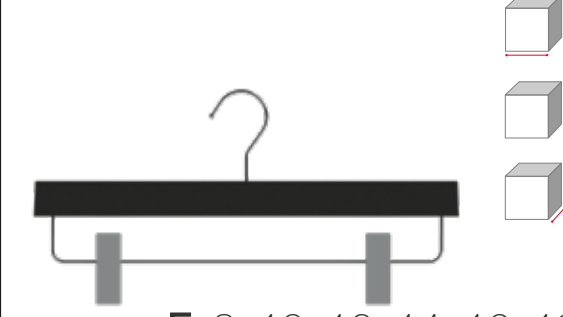

33,4cm
12,5cm
27,7mm

F: 8, 10, 12, 14, 16, 18,
S, M, L
M: 32, 34, 36, 38, 40

REF: 394

30,3cm
14,8cm
23,5mm

16, 18, 20, 22, 24, 36, 38, 40

REF: 30D

35cm
14,1cm
20,3mm

42, 44, 46,
M, L, XL, XXL, XXXL

REF: 35A

30,4cm
14,5cm
19mm

8, 10, 12, 14, 16, 18, 20,
S, M, L

REF: 6112

39,2cm
21cm
6,1mm

8, 10, 12, 14, 16, 18, 20,
S, M, L

REF: 18A

46,8cm
22,5cm
8,4mm

22, 24, 42, 44, 46,
S, M, L, XL, XXL

REF: 19B

40,5cm
20,5cm
7,5mm

REF: 20C

42,4cm
22,6cm
8,8mm

REF: 20

41,8cm
21,8cm
9mm

REF: 20A

30,3cm
14,8cm
23,5mm

16, 18, 20, 22, 24, 36, 38, 40

REF: 30D PL

35cm
14,1cm
20,3mm

42, 44, 46,
M, L, XL, XXL, XXXL

REF: 35APL

Ganchos ideales para pantalones, faldas, short, bermudas y otras prendas inferiores.

30,3cm
15,3cm
25,9mm

8, 10, 12, 14, 16, 18, 20,
S, M, L

REF: 486E

25,1cm
15,9cm
18,8mm

10, 12, 14, 16, 26, 28, 30, 32, 34,
XS, S, M, L, XL

REF: 25ACM

37,2cm
20cm
7mm

10, 12, 14, 16,
XS, S, M, L

REF: 485B

37,2cm
24cm
25,7mm

10, 12, 14, 16,
XS, S, M, L

REF: 485BP

38,2cm
21,4cm
7,2mm

10, 12, 14, 16,
XS, S, M, L

REF: 501



24,6cm
16,5cm
17,8mm

10, 12, 14, 16, 18,
S, M, L, XL

REF: 9B



23,5cm
14,8cm
23,5mm

10, 12, 14, 16, 26, 28, 30, 32, 34,
XS, S, M, L, XL

REF: 25D



25,4cm
14,5cm
20,3mm

8, 10, 12, 14, 16, 18, 20,
S, M, L

REF: 6110



24,6cm
16,5cm
17,8mm

10, 12, 14, 16, 18,
S, M, L, XL

REF: 9C



23,5cm
14,8cm
23,5mm

10, 12, 14, 16, 26, 28, 30, 32, 34,
XS, S, M, L, XL

REF: 25DPL

Ganchos ideales para pantalones, faldas, short, bermudas y otras prendas inferiores.



30cm
19,3cm
7mm

2, 4, 6, 8,
2T, 3T, 4T, 5T

REF: 498B

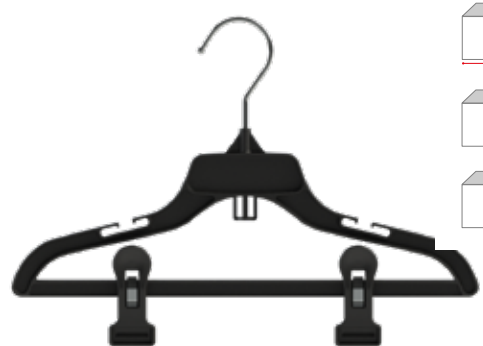

30cm
23cm
27mm

2, 4, 6, 8,
2T, 3T, 4T, 5T

REF: 498BP



19,8cm
16cm
18,8mm

2, 4, 6, 8, 10,
2T, 3T, 4T, 5T

REF: 24ACM



28,6cm
16,5cm
21mm

2, 4, 6, 8

REF: 493GK

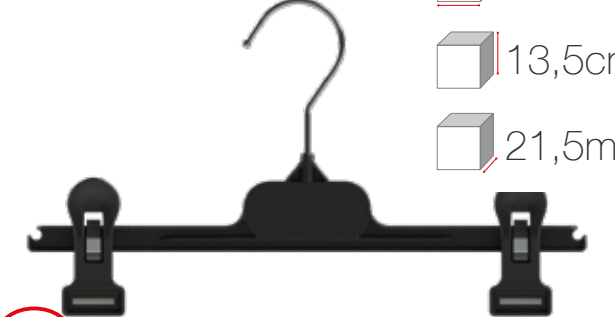

20,3cm
13,5cm
21,5mm

2, 4, 6, 8

REF: 489



26cm
38,8cm
4,5mm

2, 4, 6, 8

REF: 13E



30cm
39,3cm
4,5mm

2, 4, 6, 8

REF: 13EA



25cm
12,8cm
27,9mm

2, 4, 6, 8, 10, 12, 14, 16

REF: 393CK



25cm
12,8cm
27,9mm

2, 4, 6, 8, 10, 12, 14, 16

REF: 393CKH

19,2cm
16,9cm
6mm

2, 4, 6, 8

REF: 10

19,8cm
16,5cm
17,8mm

2, 4, 6, 8

REF: 10C

19,8cm
16,5cm
17,8mm

2, 4, 6, 8

REF: 10B

20,6cm
14,8cm
23,5mm

2, 4, 6, 8, 10,
2T, 3T, 4T, 5T

REF: 24D

17,3cm
13,5cm
21,7mm

0, 0/3, 3/6, 6/9, 9/12,
12/18, 18/24

REF: 24C

20,4cm
14,4cm
21,94mm

2, 4, 6, 8

REF: 6108

30cm
18,4cm
5,2mm

2, 4, 6, 8

REF: 14

20,5cm
29,6cm
4,7mm

2, 4, 6, 8

REF: 11-10A

20,4cm
29,6cm
4,7mm

2, 4, 6, 8

REF: 11-10A-2



30,2cm
29,5cm
4,7mm

2, 4, 6, 8

REF: 12-10



22,8cm
33,5cm
4,6mm

0, 0/3, 3/6, 6/12, 12/18,
18/24, 24/36, 38 bebe

REF: 13

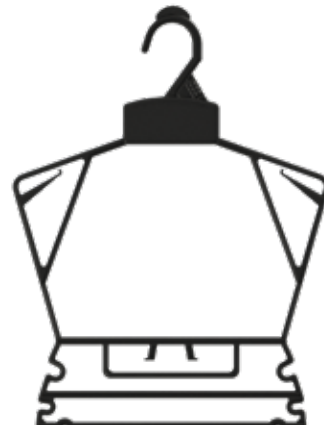

28,3cm
37,1cm
4,6mm

2, 4, 6, 8

REF: 13A



20,6m
19cm
22,6mm

2, 4, 6, 8

REF: 9408



20,5m
29,3cm
22,6mm

2, 4, 6, 8

REF: 9508



29,3cm
15,6cm
4,5mm

REF: 28A



20,6m
14,8cm
23,5mm

2, 4, 6, 8, 10,
2T, 3T, 4T, 5T

REF: 24DPL



17,3m
13,5cm
21,7mm

2, 4, 6, 8, 10,
2T, 3T, 4T, 5T

REF: 24CPL

INTERIOR

os
dados

Ganchos ideales para prendas deportivas e íntimas en general, como: brasieres, bóxers y panties.



30,6cm
11,86cm
7,2mm

8, 10, 12, 14, 16, 18, 20,
S, M, L

REF: 360



30,6cm
16,34cm
20,8mm

8, 10, 12, 14, 16, 18, 20,
S, M, L

REF: 360EG



30,2cm
16,3cm
22,2mm

8, 10, 12, 14, 16, 18, 20,
S, M, L

REF: 360EH

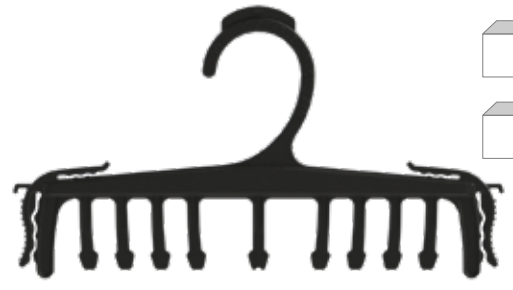

20,5cm
11,4cm
6,5mm

2, 4, 6, 8, 10, 12, 14, 16,
30, 32, 34, 36, 38, 40

REF: P8



27,5cm
9,5cm
5,9mm

30, 32, 34, 36, 38,
XS, S, M, L, XL

REF: 2C



25,4cm
10cm
4mm

10, 12, 14, 16,
30, 32, 34, 36, 38,
XS, S, M, L, XL

REF: 7E



26,5cm
10,3cm
20,5mm

10, 12, 14, 16,
30, 32, 34, 36, 38,
XS, S, M, L, XL

REF: 8



27,4cm
11,6cm
18,7mm

10, 12, 14, 16,
30, 32, 34, 36, 38,
XS, S, M, L, XL

REF: 8C



25,4cm
10,4cm
4,4mm

10, 12, 14, 16,
30, 32, 34, 36, 38,
XS, S, M, L, XL

REF: 4S



19,6cm
14,5cm
3,3mm

2, 4, 6, 8

REF: 5B-4



20cm
16,8cm
4mm

10, 12, 14, 16,
30, 32, 34, 36, 38,
XS, S, M, L, XL

REF: 5L-3



26,5cm
13,5cm
4,5mm

10, 12, 14, 16,
30, 32, 34, 36, 38,
XS, S, M, L, XL

REF: 7L-2



26,5cm
15,5cm
4,5mm

10, 12, 14, 16,
30, 32, 34, 36, 38,
XS, S, M, L, XL

REF: 7L-3



27cm
9,8cm
4,5mm

10, 12, 14, 16,
30, 32, 34, 36, 38,
XS, S, M, L, XL

REF: 7-2



27cm
10,4cm
4,5mm

10, 12, 14, 16,
30, 32, 34, 36, 38,
XS, S, M, L, XL

REF: 7-3



25,5cm
11,6cm
6,5mm

10, 12, 14, 16,
30, 32, 34, 36, 38,
XS, S, M, L, XL

REF: 6B



28,6cm
12,1cm
4,9mm

10, 12, 14, 16,
30, 32, 34, 36, 38,
XS, S, M, L, XL

REF: 7C



15,3cm
7,1cm
5mm

12, 14, 16,
30, 32, 34, 36, 38, 40, UNICA

REF: 04A



15,3cm
10cm
5mm

12, 14, 16,
30, 32, 34, 36, 38, 40

REF: 04A-2



15,3cm
10cm
5mm

12, 14, 16,
30, 32, 34, 36, 38, 40

REF: 04A-3



16,5cm
10,2cm
8,4mm

12, 14, 16,
30, 32, 34, 36, 38, 40

REF: 04E



16,5cm
12,2cm
8,4mm

12, 14, 16,
30, 32, 34, 36, 38, 40

REF: 04E-2



20,5cm
11,4cm
6,5mm

2, 4, 6, 8, 10, 12, 14, 16,
30, 32, 34, 36, 38, 40

REF: P8

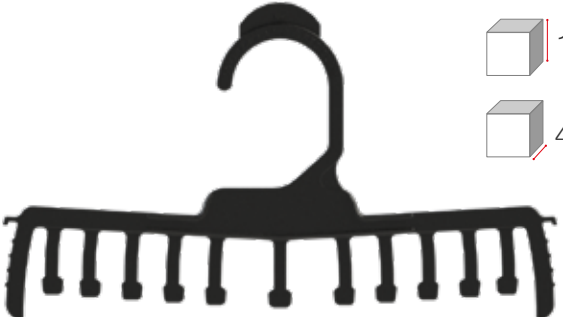

21,3cm
12,4cm
4,1mm

12, 14, 16,
30, 32, 34, 36, 38, 40

REF: P12



25,5cm
11,6cm
6,5mm

10, 12, 14, 16,
30, 32, 34, 36, 38,
XS, S, M, L, XL

REF: 6B

Ganchos ideales que permiten colgar dos o más prendas en conjunto, para el armado de outfits completos.

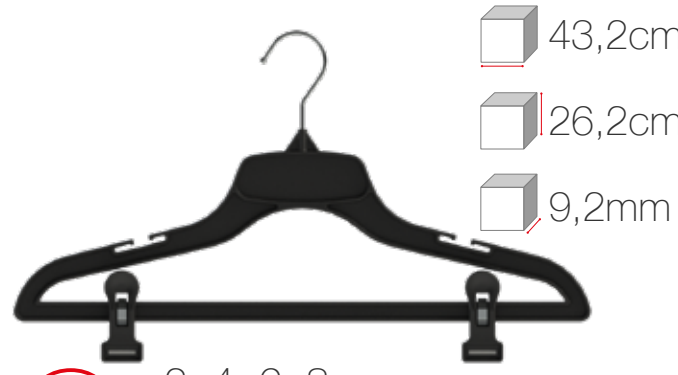

43,2cm
26,2cm
9,2mm

2, 4, 6, 8,
2T, 3T, 4T, 5T

REF: 484BP

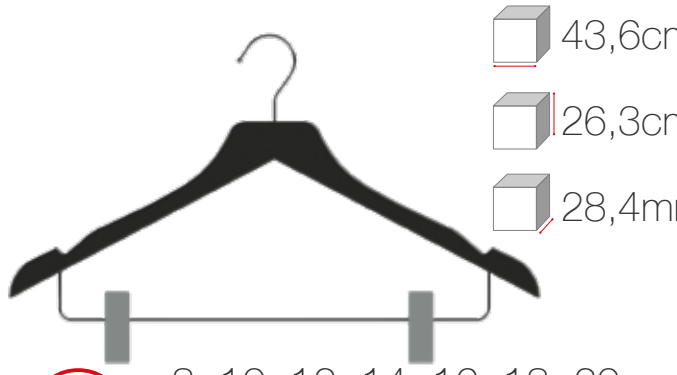

43,6cm
26,3cm
28,4mm

8, 10, 12, 14, 16, 18, 20,
S, M, L

REF: 390A

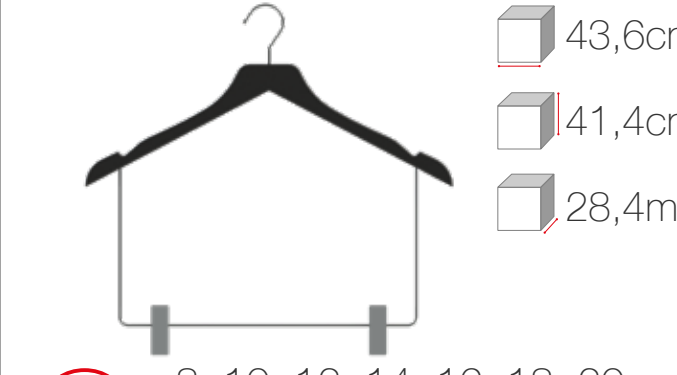

43,6cm
41,4cm
28,4mm

8, 10, 12, 14, 16, 18, 20,
S, M, L

REF: 390B

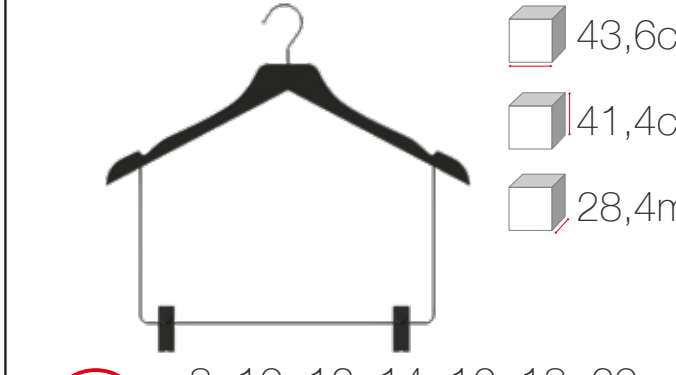

43,6cm
41,4cm
28,4mm

8, 10, 12, 14, 16, 18, 20,
S, M, L

REF: 390BF

ADULTO



37,2cm
20cm
7mm

10, 12, 14, 16,
XS, S, M, L

REF: 485B

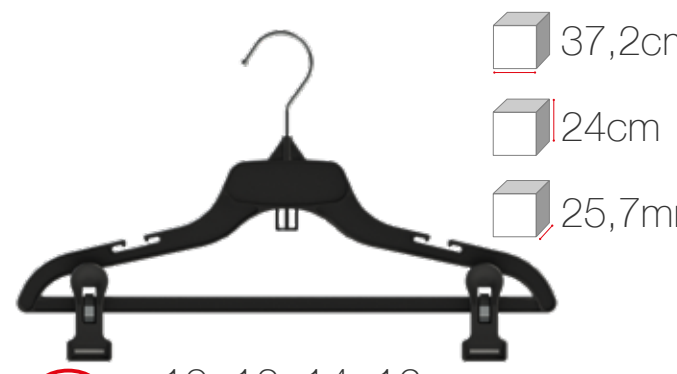

37,2cm
24cm
25,7mm

10, 12, 14, 16,
XS, S, M, L

REF: 485BP

JUNIOR

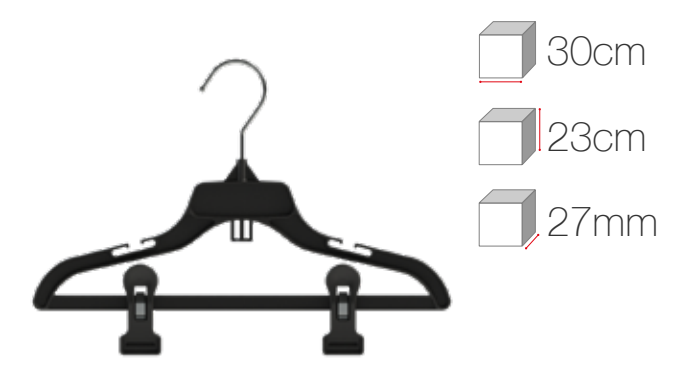

30cm
23cm
27mm

2, 4, 6, 8,
2T, 3T, 4T, 5T

REF: 498BP

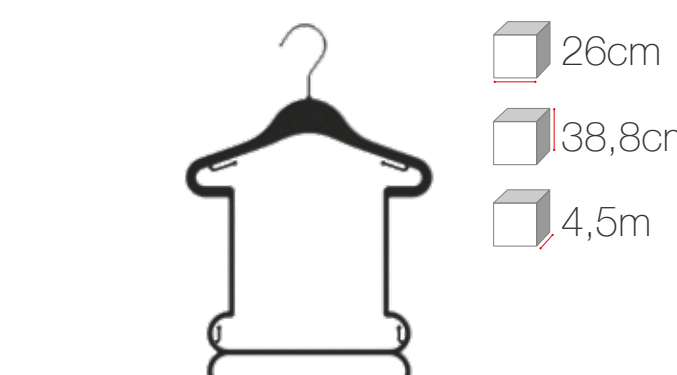

26cm
38,8cm
4,5mm

2, 4, 6, 8,

REF: 13E



30cm
39,3cm
4,5mm

2, 4, 6, 8,

REF: 13EA

INFANTIL

Ganchos ideales que permiten colgar dos o más prendas en conjunto, para el armado de outfits completos.

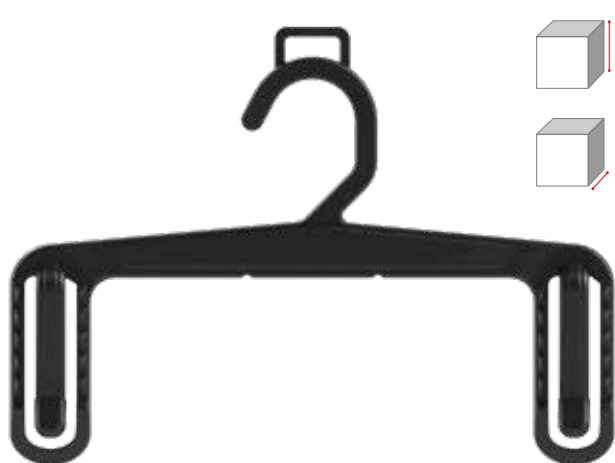

24,6cm
16,5cm
17,8mm

F: 10, 12, 14, 16, 18
S, M, L, XL

REF: 9B



43,2cm
21,2cm
12,2mm

F: 12, 14, 16, 18
M: 34, 36, 38, 40, XS, S, M, L

REF: 17H



43,1cm
32,8cm
12,2mm

F: 12, 14, 16, 18
M: 34, 36, 38, 40, XS, S, M, L

REF: 17ST

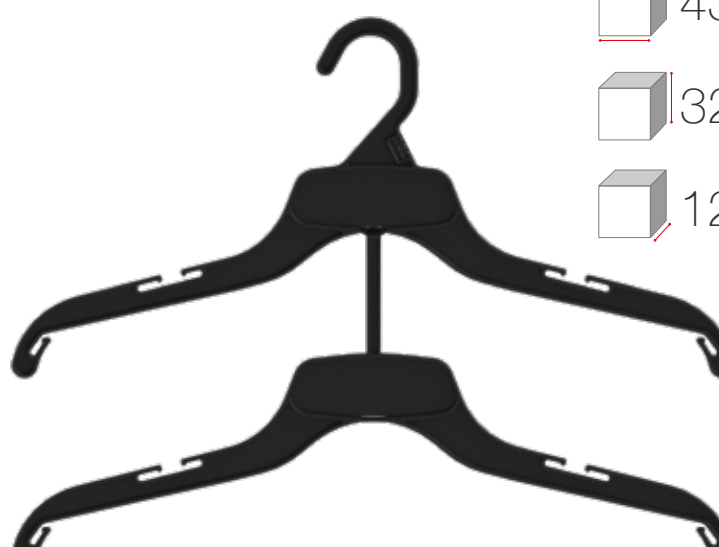

43,1cm
32,8cm
12,2mm

F: 12, 14, 16, 18
M: 34, 36, 38, 40, XS, S, M, L

REF: 17DUO

Ganchos ideales que permiten colgar dos o más prendas en conjunto, para el armado de outfits completos.



24,6cm
16,5cm
17,8mm

10, 12, 14, 16, 18
S, M, L, XL

REF: 9B



37,7cm
18,5cm
6mm

8, 10, 12, 14, 16,
XS, S, M

REF: 16

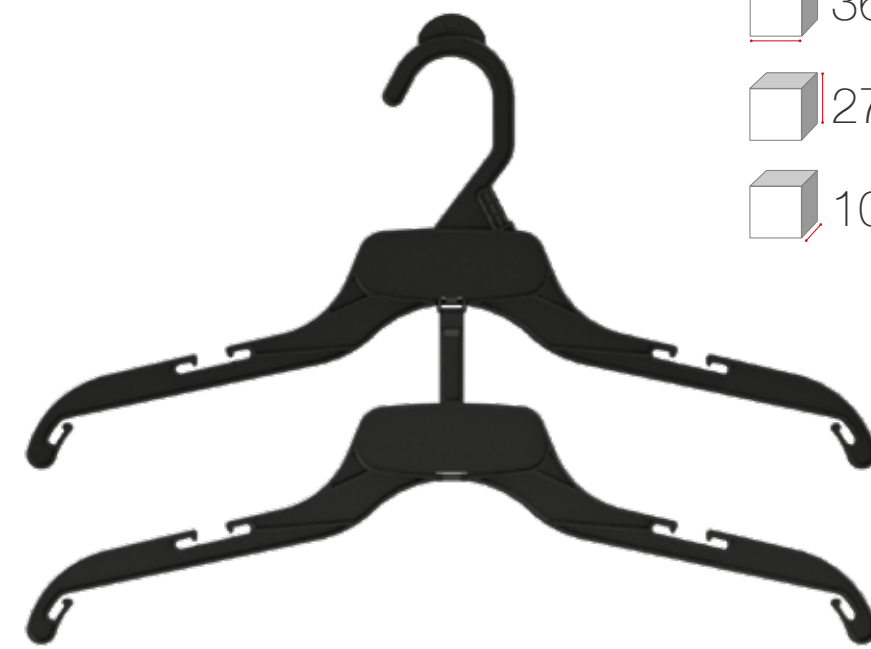

36,2cm
27,1cm
10mm

10, 12, 14, 16,
XS, S, M, L

REF: 15DUO



22cm
14cm
6mm

0, 0/3, 3/6, 6/12, 12/18,
18/24, 24/36, 38 BEBE

REF: 11-2



22cm
16,3cm
6,1mm

0, 0/3, 3/6, 6/12, 12/18,
18/24, 24/36, 38 BEBE

REF: 11-3



22cm
21cm
6,2mm

0, 0/3, 3/6, 6/12, 12/18,
18/24, 24/36, 38 BEBE

REF: 11-5



20,5cm
29,6cm
4,7mm

2, 4, 6, 8

REF: 11-10A



19,8cm
16,5cm
17,8mm

2, 4, 6, 8

REF: 10B



20,4cm
29,6cm
4,7mm

0, 0/3, 3/6, 6/12, 12/18,
18/24, 24/36, 38 BEBE

REF: 11-10A2



30,2cm
29,5cm
4,7mm

2, 4, 6, 8

REF: 12-10A

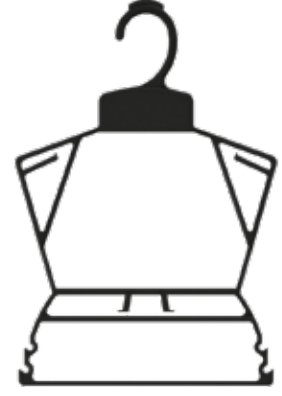

22,8cm
33,5cm
4,6mm

0, 0/3, 3/6, 6/12, 12/18,
18/24, 24/36, 38 BEBE

REF: 13

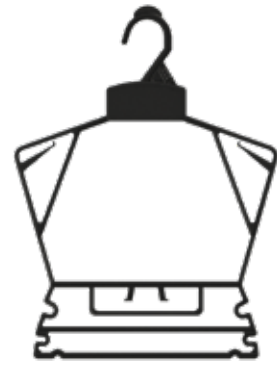

28,3cm
37,1cm
4,6mm

2, 4, 6, 8

REF: 13A



19,8cm
16,5cm
17,8mm

2, 4, 6, 8

REF: 10C



20,6m
19cm
22,6mm

2, 4, 6, 8

REF: 9408



20,5m
29,3cm
22,6mm

2, 4, 6, 8

REF: 9508



19,2cm
16,9cm
6mm

2, 4, 6, 8

REF: 10



30,6cm
23,4cm
10,2mm

2, 4, 6, 8,
2T, 3T, 4T, 5T

REF: 12DUO

SWIMWEAR



Ganchos ideales para exhibir trajes de baño, bikinis, prendas deportivas y ropa de playa.

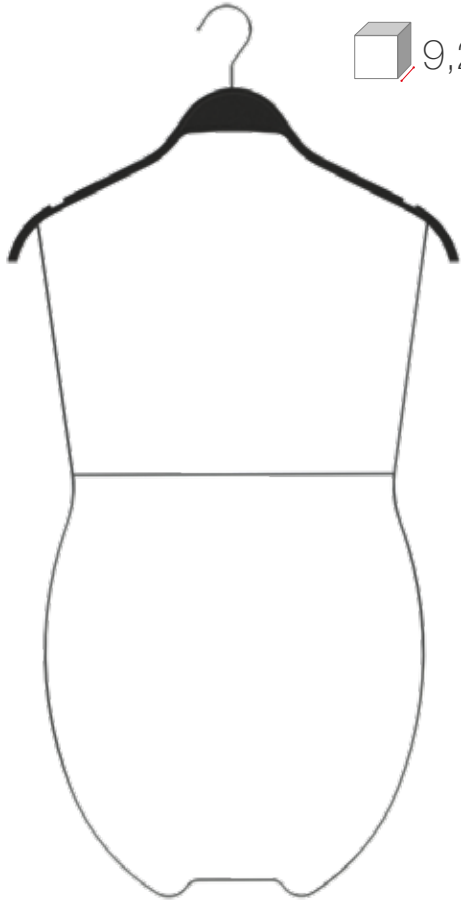

39,5cm
79cm
9,2mm

REF: 003

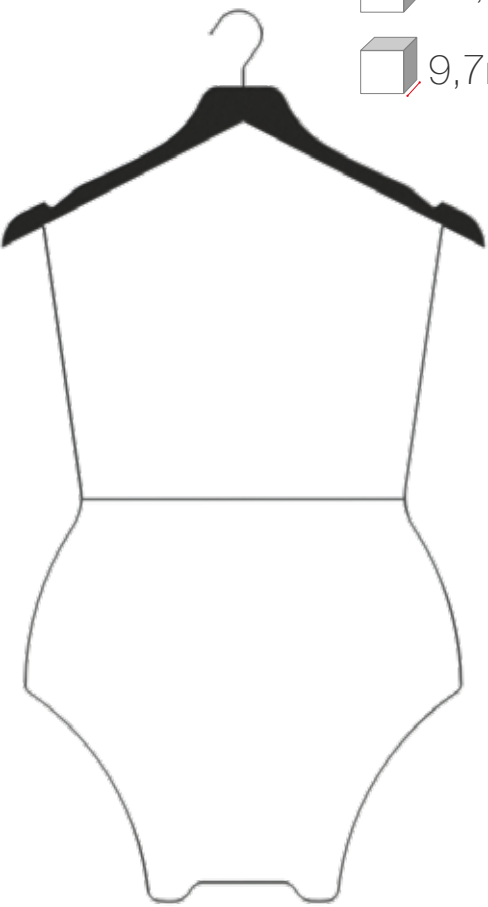

43,6cm
81,4cm
9,7mm

REF: 005

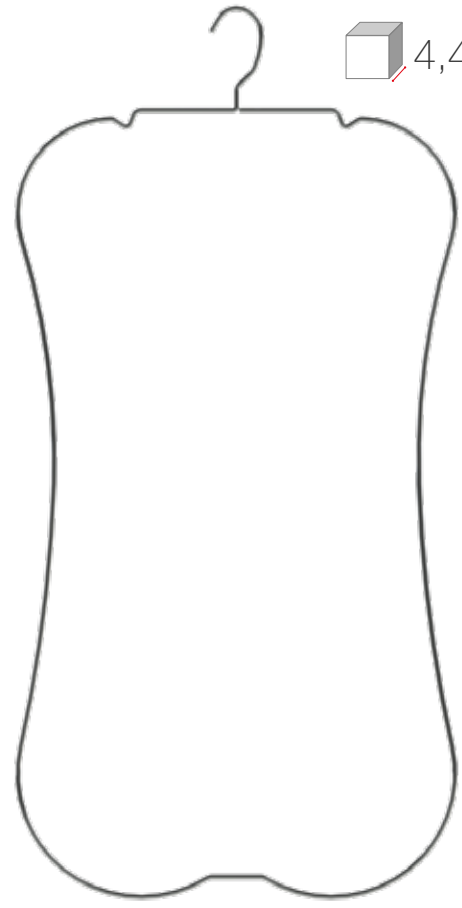

40,3cm
81cm
4,4mm

REF: 014



43,6cm
26,3cm
28,4mm

8, 10, 12, 14, 16, 18, 20,
S, M, L

REF: 390A



43,6cm
41,4cm
28,4mm

8, 10, 12, 14, 16, 18, 20,
S, M, L

REF: 390B



30,6cm
16,34cm
20,8mm

8, 10, 12, 14, 16, 18, 20,
S, M, L

REF: 360EG



26,5cm
12cm
6,5mm

10, 12, 14, 16,
30, 32, 34, 36, 38, XS,
S, M, L, XL

REF: 6B

MULTIUSOS

Accesorios para exhibir toda clase de calzado.

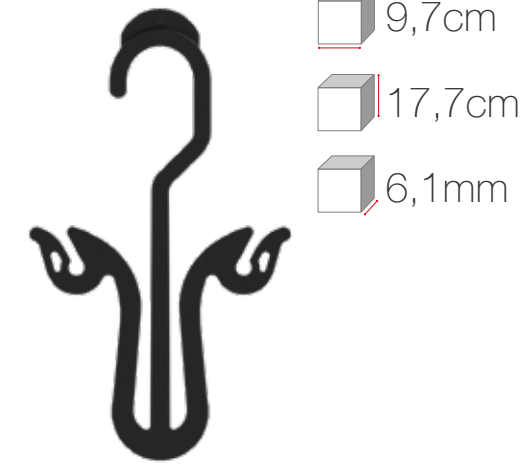

9,7cm
17,7cm
6,1mm

REF: 014B



11,2cm
28,6cm
8,4mm

REF: 014C



9,7cm
7,8cm
2mm

REF: 015A



10,5cm
9,2cm
2,3mm

REF: 016B



3,9cm
14cm
28,8mm

REF: 017



3,47cm
8,54cm
18,6mm

REF: 017A





4,2cm
13,6cm
34,4mm

REF: 017C



Accesorios para colgar todo clase cinturones y correas. Adaptándose a diferentes hebillas



-  4cm
-  14,1cm
-  6mm

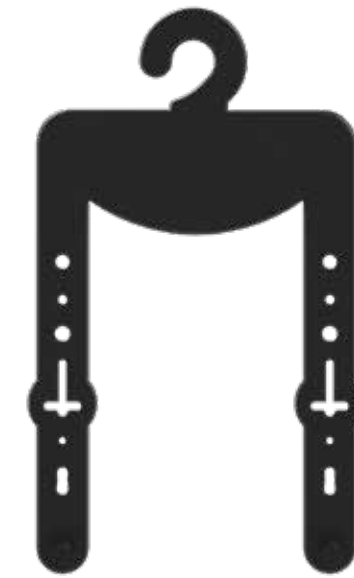

REF: 08



-  7,7cm
-  12,6cm
-  6,3mm



REF: 08-2



-  4,5cm
-  19,6cm
-  3mm



REF: 08A



-  4,5cm
-  7cm
-  3mm



REF: 08B



-  4,1cm
-  17,5cm
-  3,6mm

REF: 08C



-  3cm
-  10cm
-  14mm

REF: 08D

Accesorios para artículos preempacados de tamaño y peso medio.



3,4cm
5,3cm
7,9mm

REF: 02



2cm
3,9cm
6mm

REF: 05A



4,9cm
7,6cm
6,9mm

REF: 07L



11,6cm
7,2cm
8,3mm

REF: 07S



7,8cm
4,4cm
1,9mm

REF: 03D



14,8cm
6,4cm
1,8mm

REF: 07C



Accesorios que permiten organizar pares o promociones de medias.

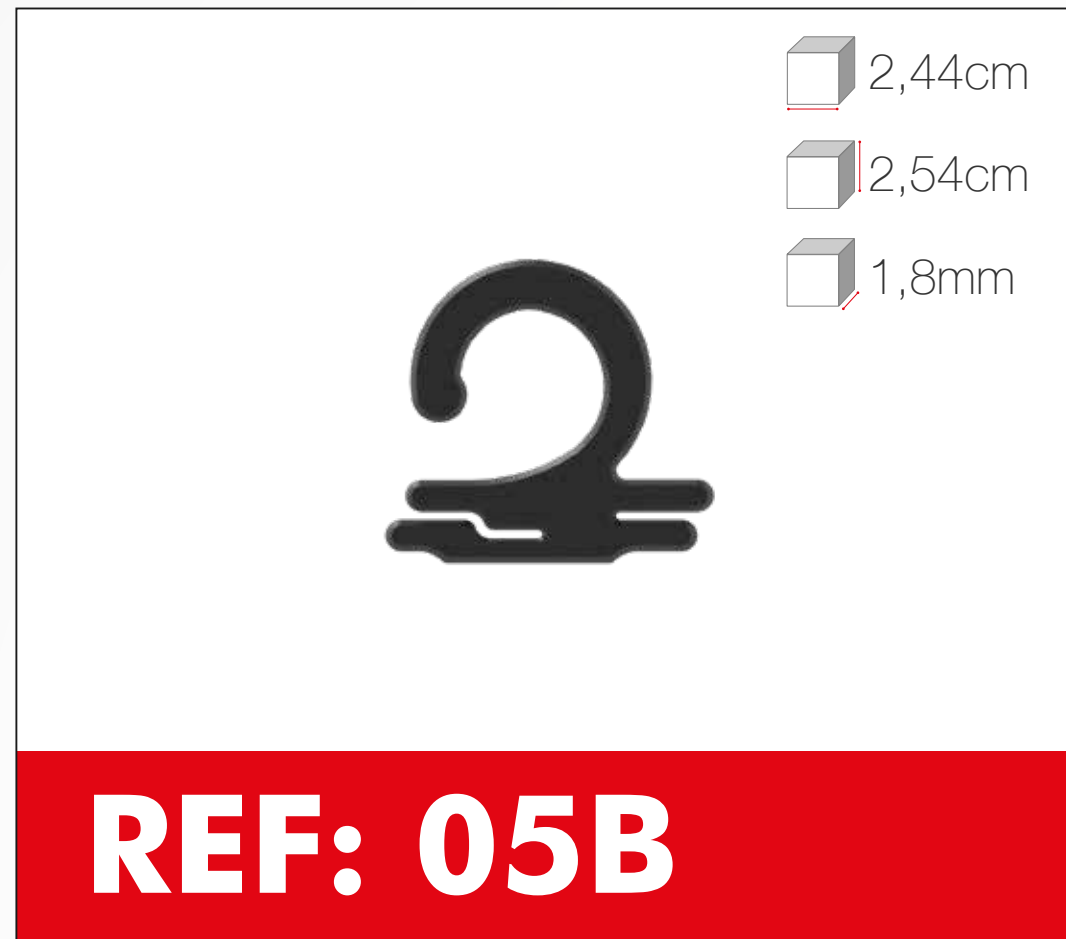

ALGODÓN SOSTENIBLE

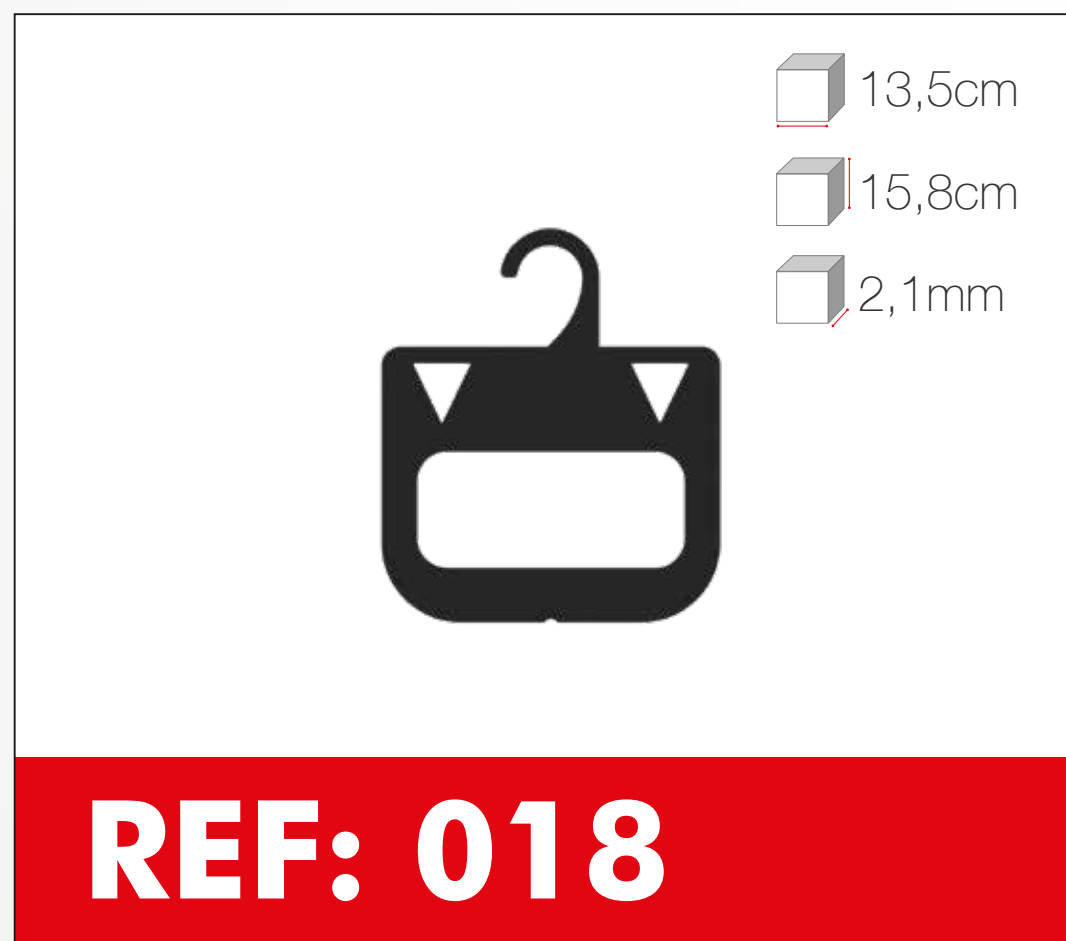

Accesorios para exhibir pañuelos, bufandas, o muestras de tela en exhibición.

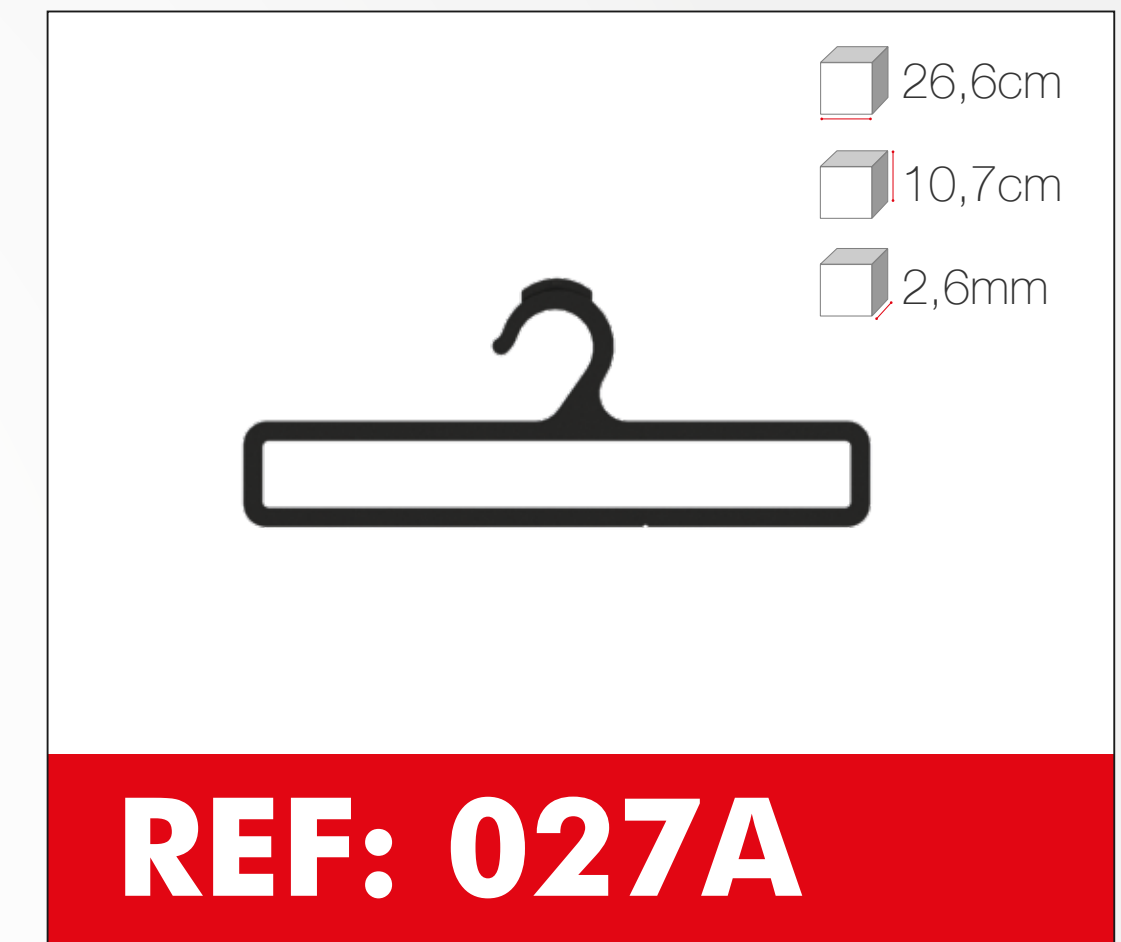
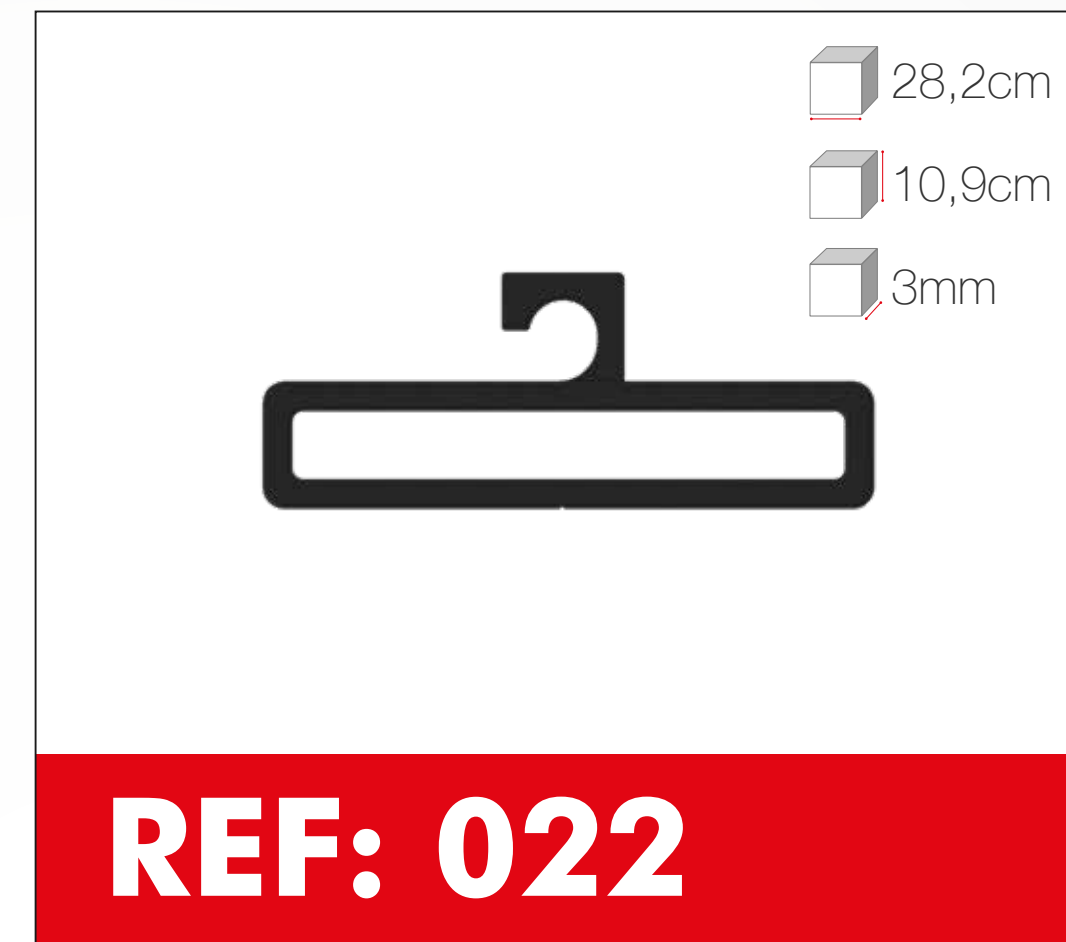
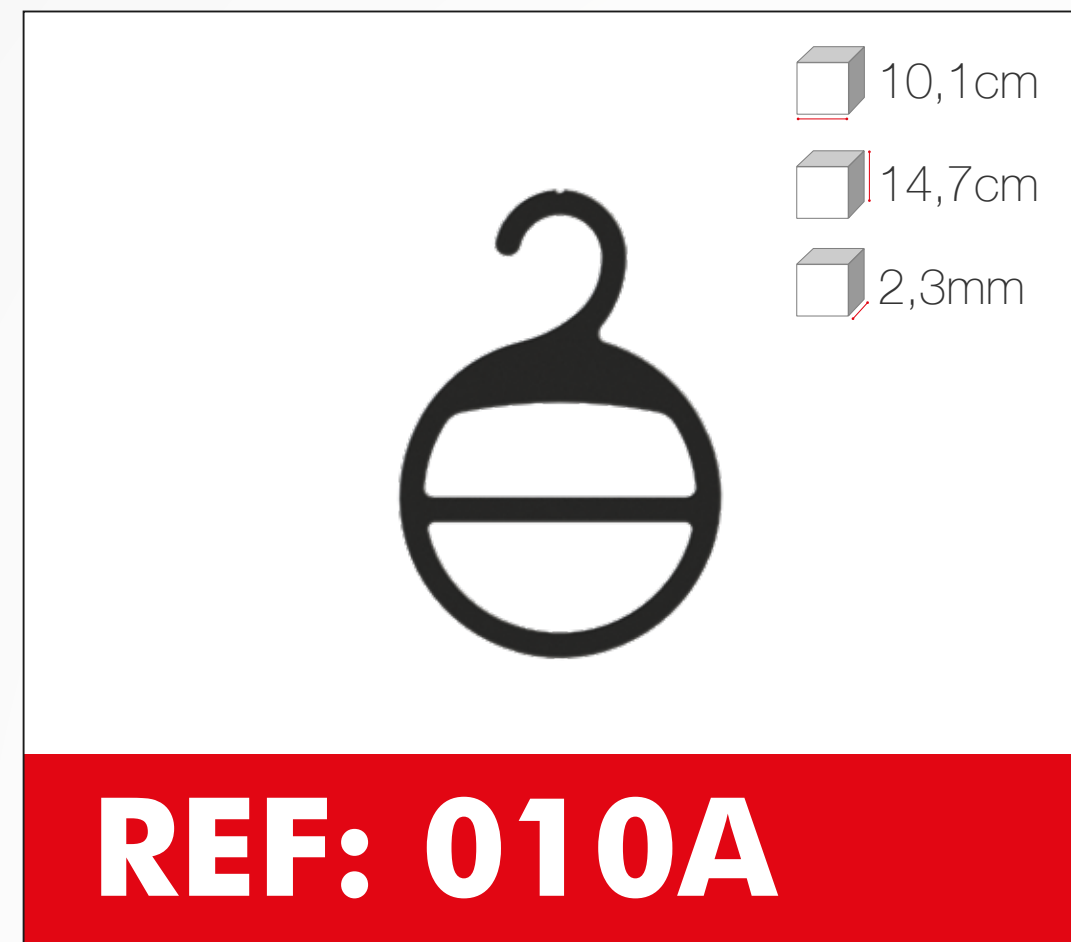

ACCESORIOS





CAJA #2
14,3cm 19,7cm 52mm

TALLA
SUPERIOR
34,9mm 15,4mm 4,75mm



TALLA
CIRCULAR
13,2mm 9,3mm



TALLA
CUADRADA
14,3mm 13,6mm



TALLA
ELIPTICA
20,2mm 13,3mm 10,1mm



SEPARADOR DE TALLA
S1
9mm 2,8mm



SEPARADOR DE TALLA
S2
11,7mm 3,2mm

ANTIDESLIZANTE
032
(GANCHO 484)
1,81cm 9,9mm 2,7mm



PROTECTOR GANCHOS
PINZA
25,9cm 6,9mm 6,2mm

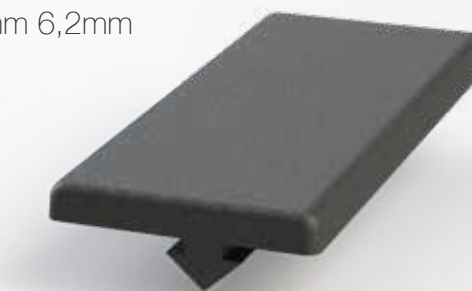

Ganchos para almacenar todo tipo de prendas, mantienen el orden y optimizan el espacio del closet.

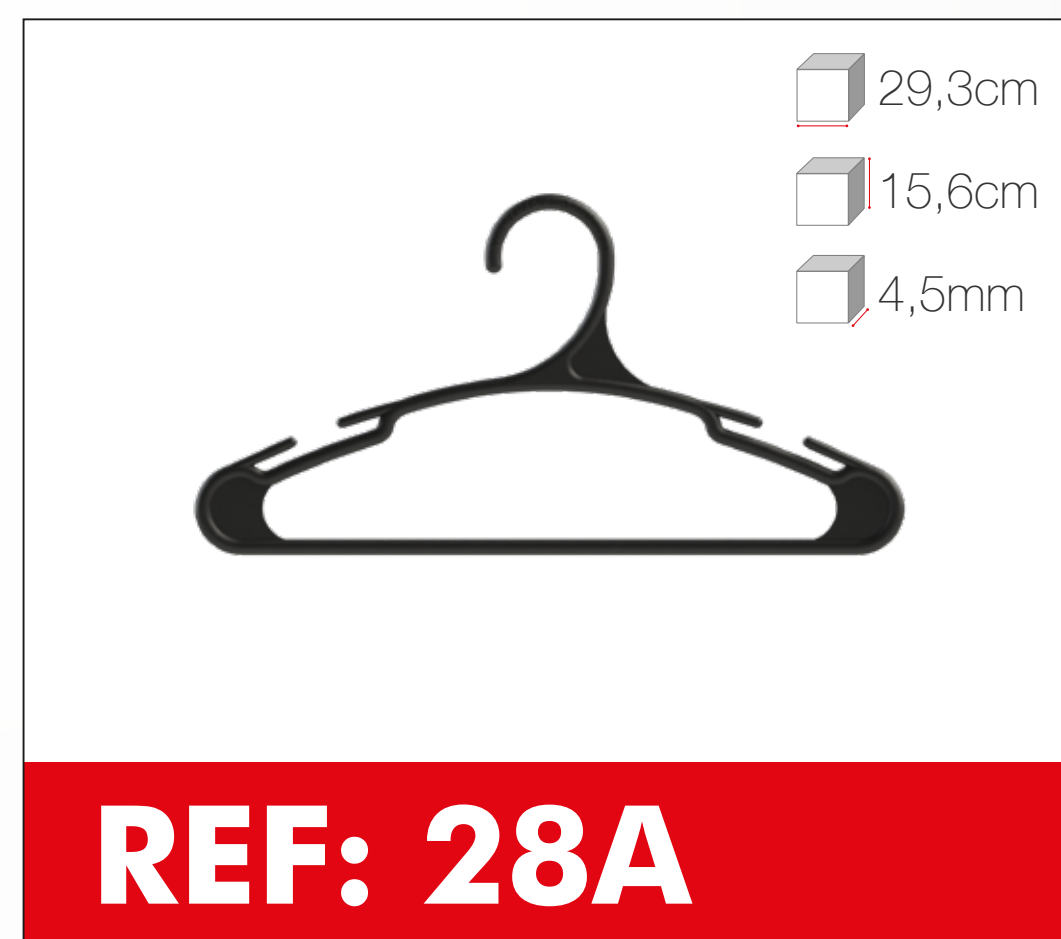
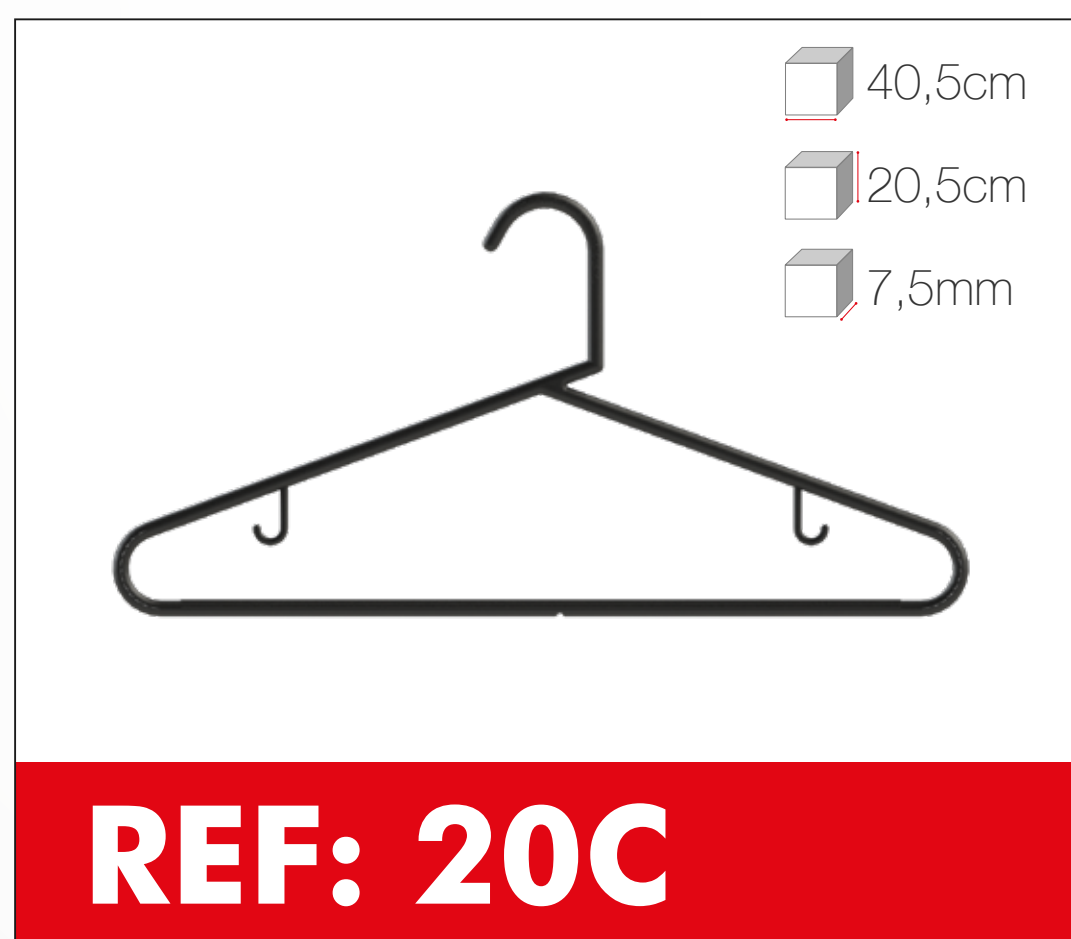
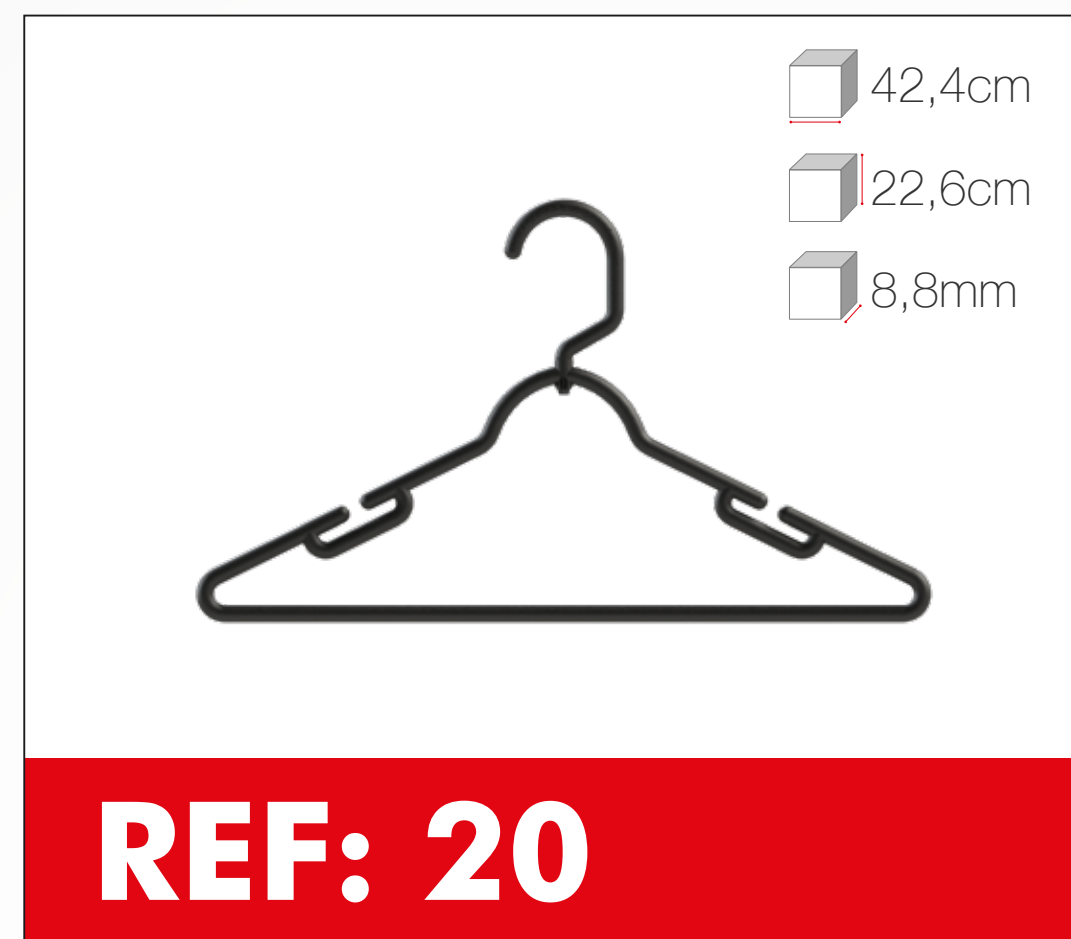

Ganchos para exhibir y almacenar todo tipo de prendas para mascotas.



REF: 11F

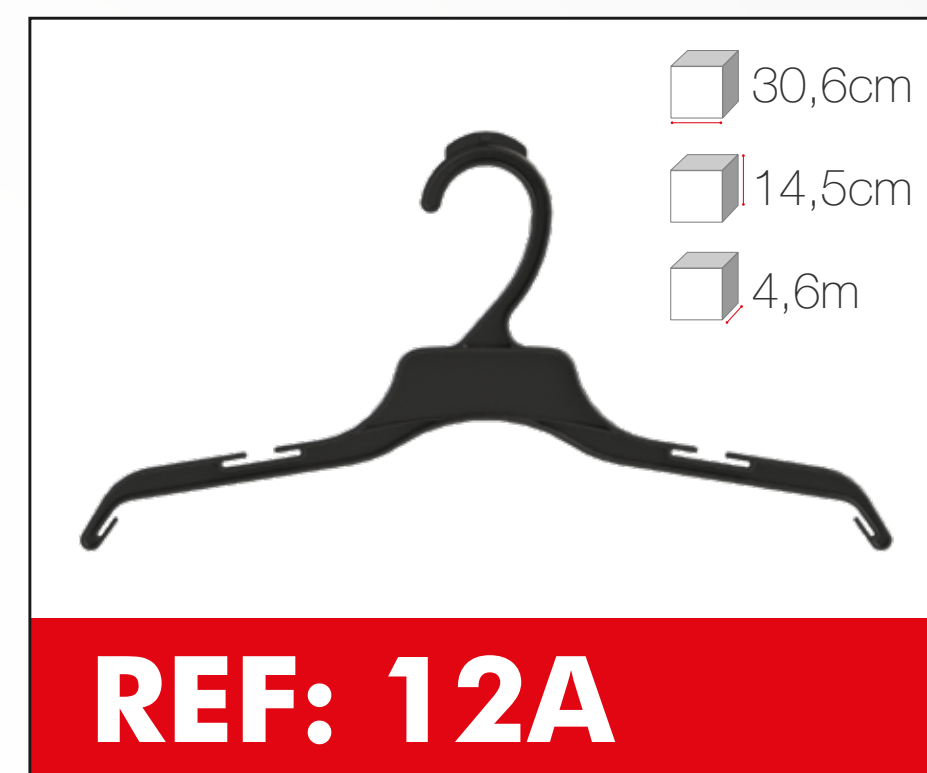
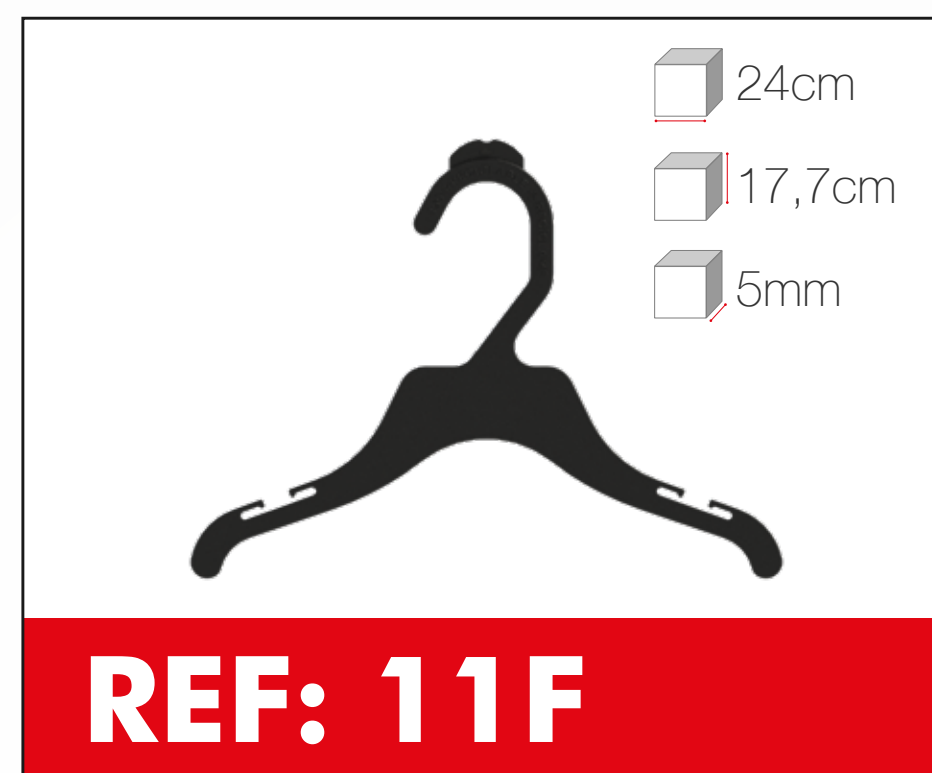

REF: P8

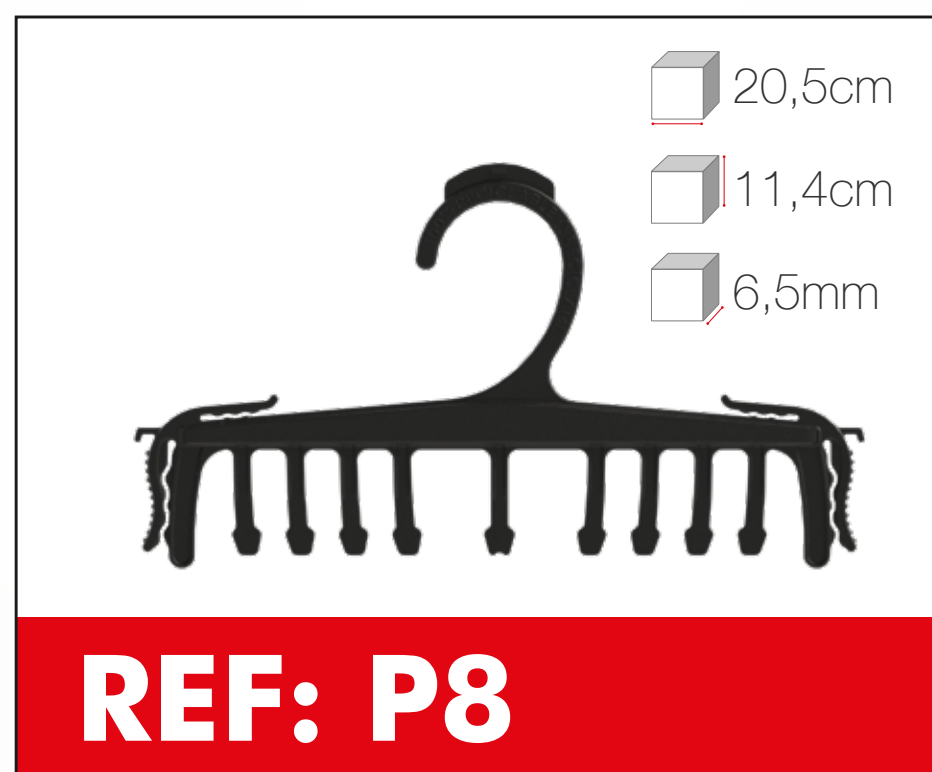

CAJA PLEGABLE 10K

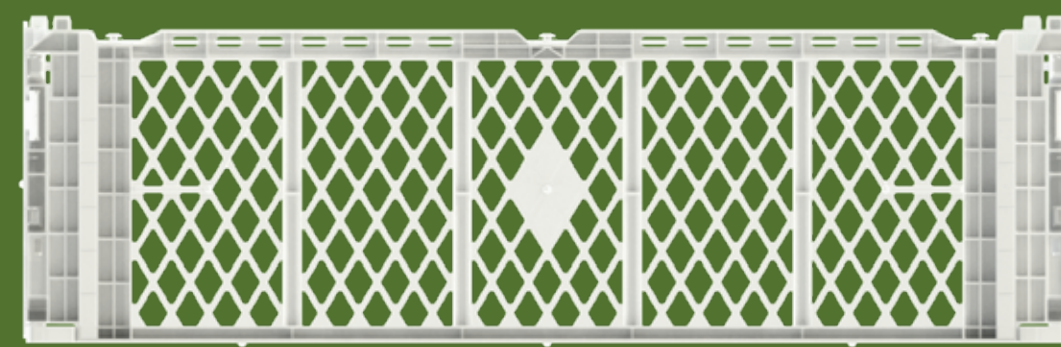
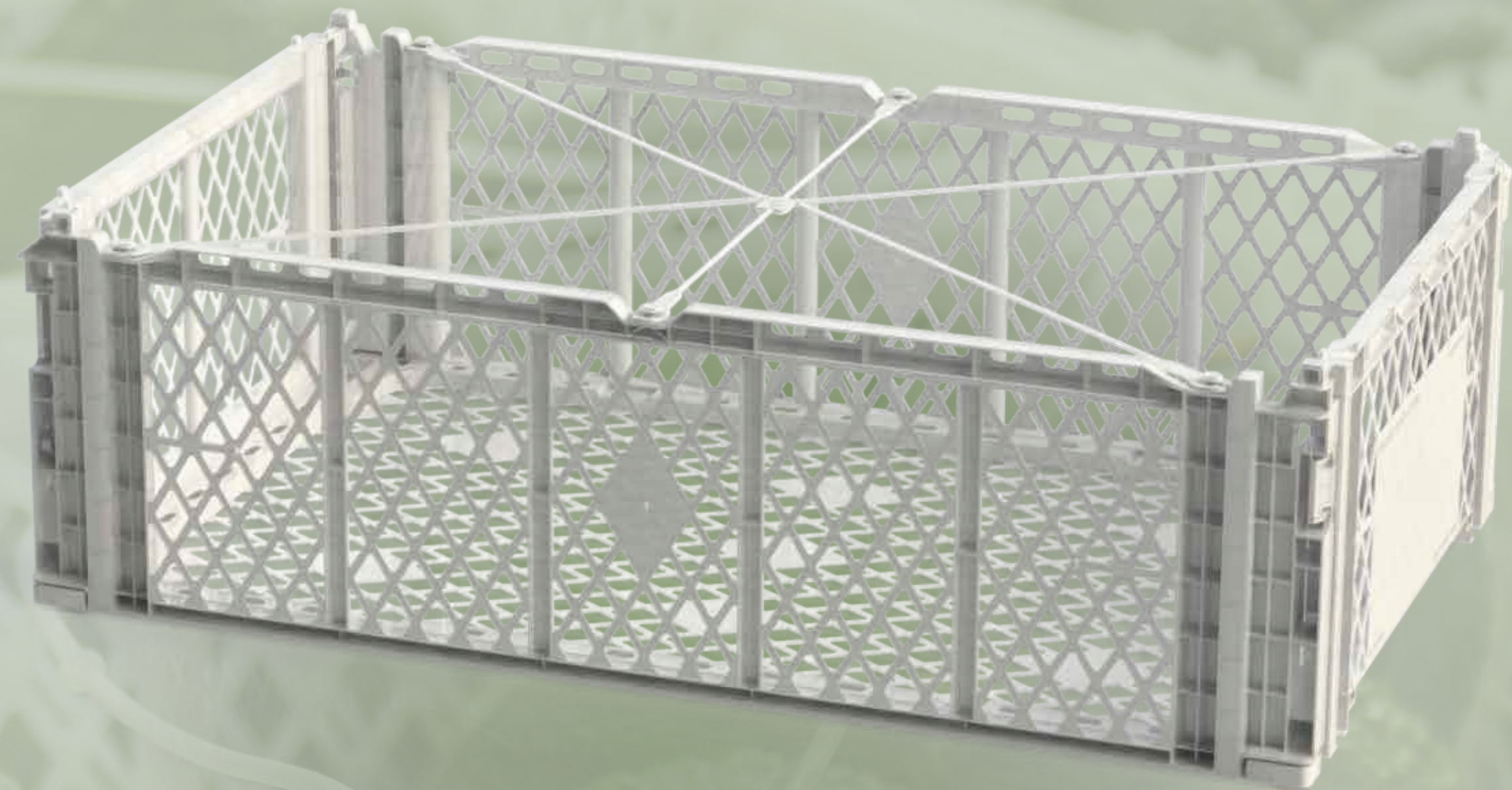

50.5CM



30.3CM

Caja organizadora, multiusos y plegable ideal para el empaque y transporte de alimentos, bodegaje y almacenamiento de todo tipo de elementos. También para organizar y economizar espacio en apilamiento vertical, transportar, distribuir y manipular mercancías o productos varios en el hogar.

RECUPERAMOS gran cantidad de los ganchos que comercializamos. Muchos retornan a nuestras instalaciones para ser seleccionados cuidadosamente para ser distribuidos nuevamente en el mercado a un precio más económico.

REPARAMOS con tecnología avanzada todo lo posible antes de descartar. Nuestros productos son reparados para minimizar residuos.

REDISTRIBUIMOS productos usados que recogemos, los seleccionamos y vendemos a menor precio.

RECICLAMOS todos nuestros productos y luego de cumplir el ciclo de usabilidad retornan a nuestras instalaciones para volver a convertirse en un producto totalmente renovado.

REDUCIMOS el uso de agua y energía y monitoreamos operaciones en tiempo real con tecnología.

REUTILIZAMOS muchos elementos e insumos principalmente la materia prima. Internamente no hay desperdicio, toda la materia prima se reutiliza.

REPENSAMOS, revisamos y actualizamos continuamente nuestros procesos. En un mundo cambiante, lo que fue efectivo antes puede ser obsoleto ahora.

REFABRICAMOS nuestros moldes para hacer ganchos más livianos y resistentes y duplicamos su productividad para usar menos energía y menos recursos en su producción.

REDISEÑAMOS constantemente nuestros productos y nuestros procesos para hacerlos más eficientes y productivos, esto repercute en el uso de menos recursos

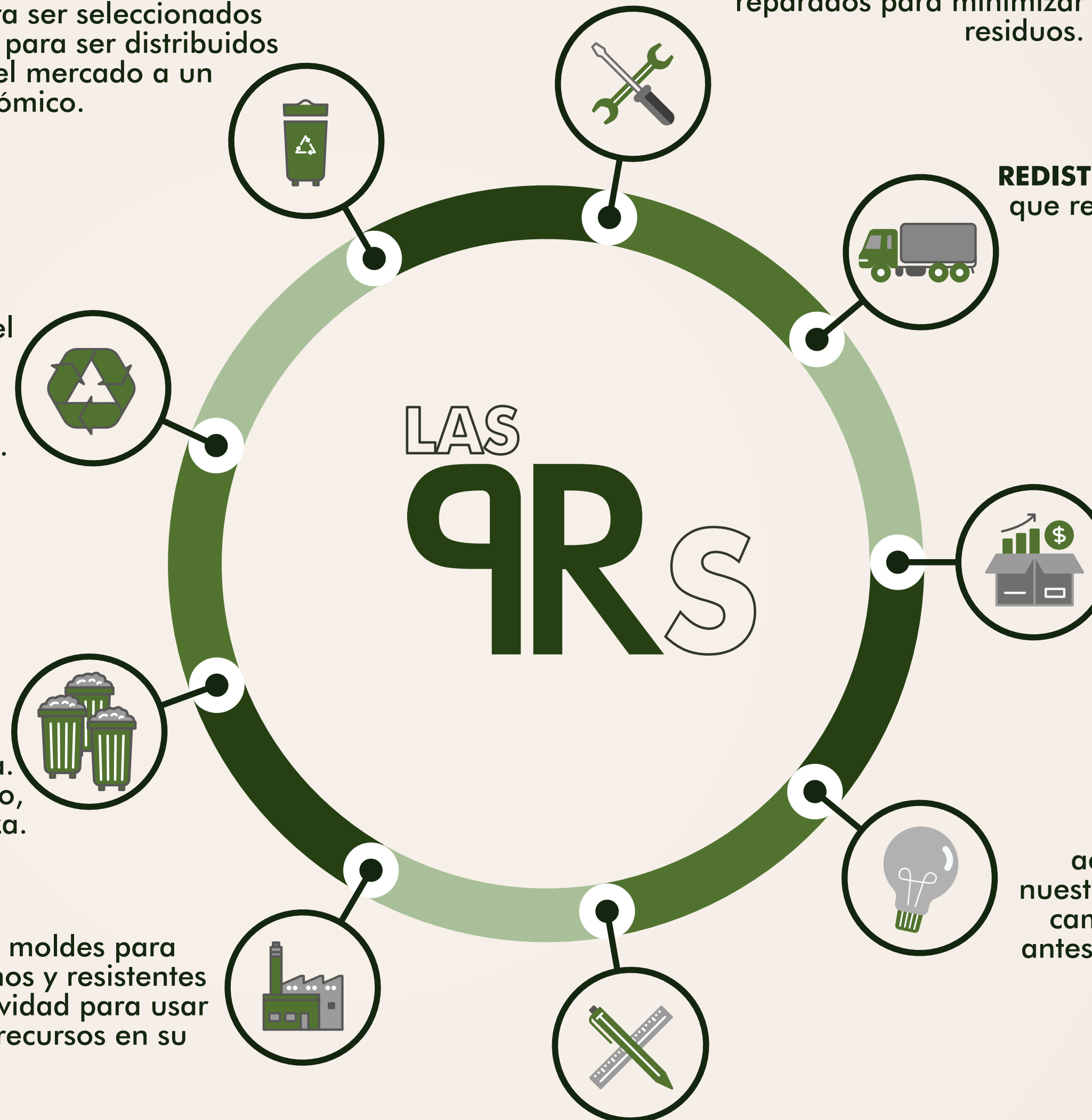

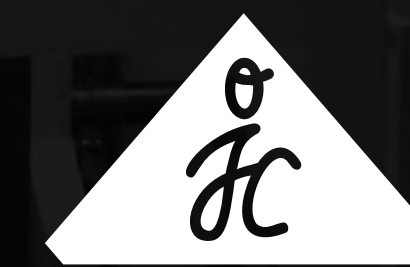

OJARA S.A.

CRA 42 # 54A – 155 / BODEGA 2
ITAGUI – ANTIOQUIA, COLOMBIA
(+57) 444 48786
(+57) 315 266 4566
CLIENTE@OJARA.COM